

The logo for iXblue features the text "iXblue" in a bold, black, sans-serif font. A small, solid blue circle is positioned above the letter "i".

**iXblue**

**iXblue Photonics**

**Distributed Brillouin  
Sensors applications**

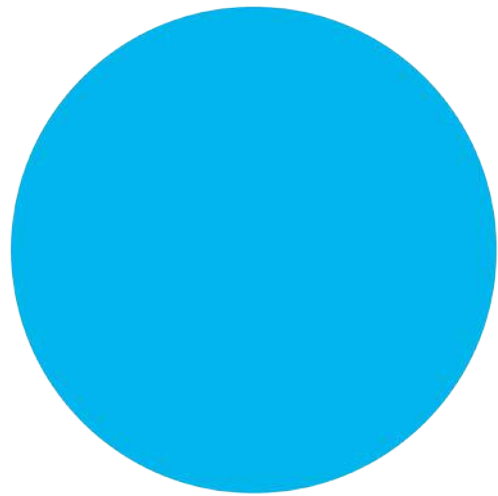

# **Brillouin Optical Time Domain Analyser (BOTDA)**

**Application: Distributed Fiber  
Strain Sensing**



# Description

- BOTDA is a class of industrial fiber optic sensor commercially available.
- Applications : civil engineering (bridges, road, dam), pipeline & cable monitoring
- Principle : Brillouin scattering shows a down-shifted frequency compared with an input lightwave.
- Brillouin frequency shift :  $2nV_a/\lambda_o = 11.25\text{GHz}$  in silica optical fiber
- The frequency shift : changed with longitudinal strain and or temperature modification applied to the fiber.
- Acoustic velocity in the fiber :  $(K/\rho)^{1/2}$
- Density  $\rho$  : depends on stress and temperature
  
- Practical limitation of the spatial resolution in the pulse-based time domain techniques turns out to be 1m
- Type : distributed sensor (50-100kms of SMF)
- Number of points : 50,000-100,000

# Scattering Brillouin Sensor – Set-up exemple

## Measurements: Distributed Temperature & Strain

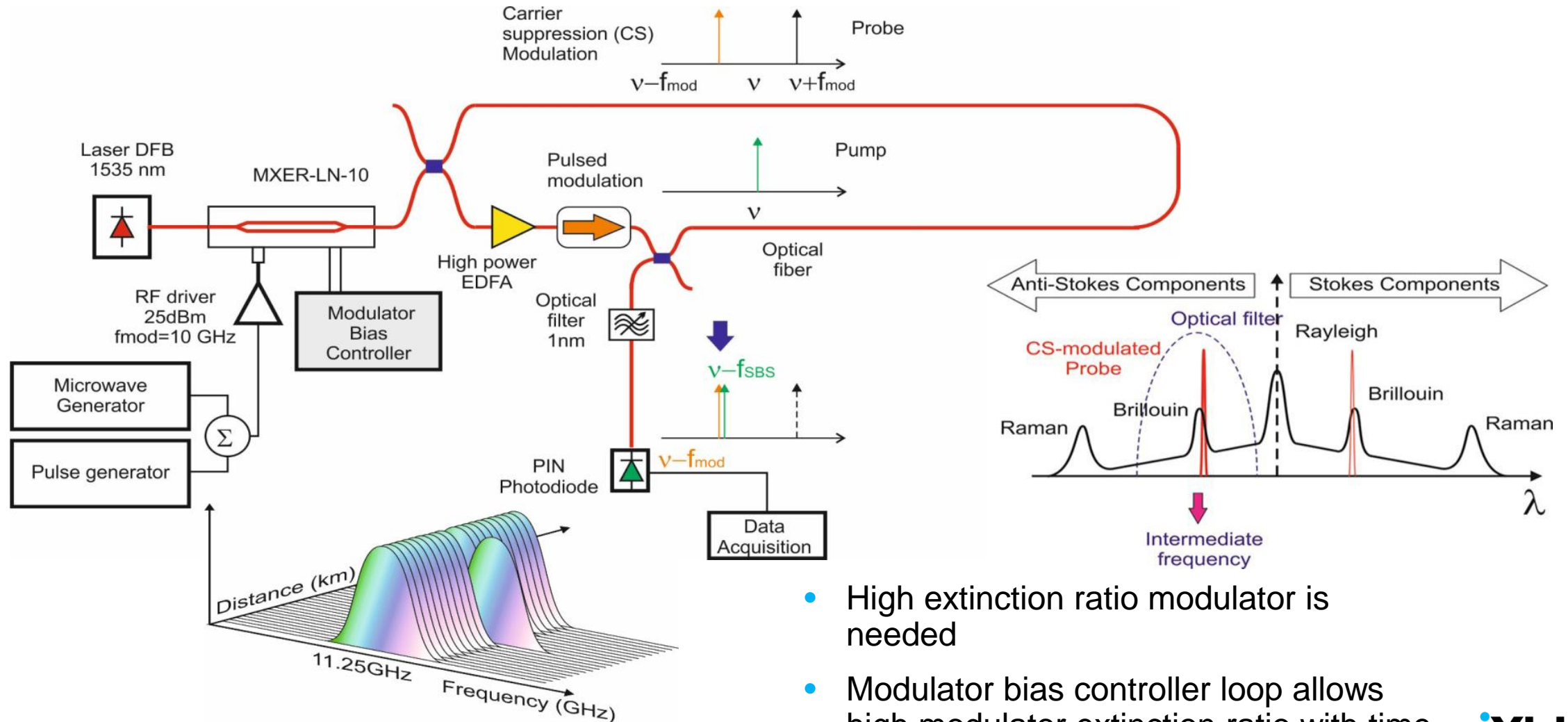

- High extinction ratio modulator is needed
- Modulator bias controller loop allows high modulator extinction ratio with time

# Description of the Modulator used in BOTDA

- Mach-Zehnder modulators are required in Brillouin scattering fiber sensor.
- It allows applying probing pulse able to be amplified by a high power optical amplifier.
- To generate the 11.25GHz dual side band modulation with carrier suppression. Broadband is required
- A high static extinction ratio >40dB is required for the operation of the probe to avoid spurious interferences with rayleigh scattering in particular
- A low driving voltage allows to get a high electro-optic efficiency and powerfull side band modulation
- Low insertion loss is mandatory to get more power in the sensing fiber, the Brillouin scattering being a very weak effect

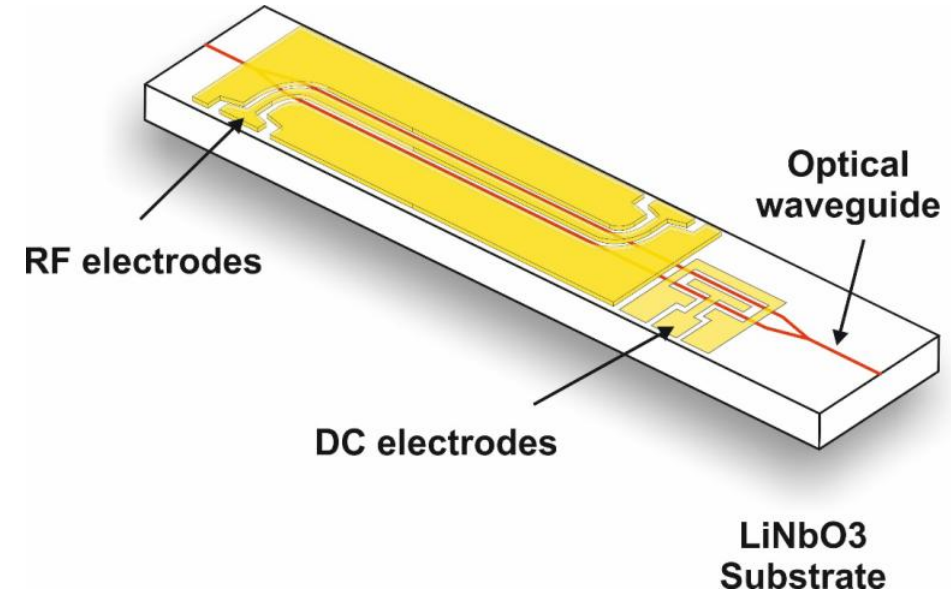

- Wave guide circuit : Mach-Zehnder modulators
- RF electrodes separated from DC electrodes
- Titanium diffusion on X-cut and Y-prop LiNbO3

# Illustration of the dual side band modulation and of pulse modulation at 1550nm

- Mach-Zehnder modulator is biased at minimum of transmission
- The driving voltage is  $\geq V_p$  for the RF signal
- The modulation frequency is near 11.25GHz
- Two sides band are generated in the optical spectrum
- Time domain analysis shows a 22.5GHz modulation
- Example of a 10ns optical pulse at 1550nm

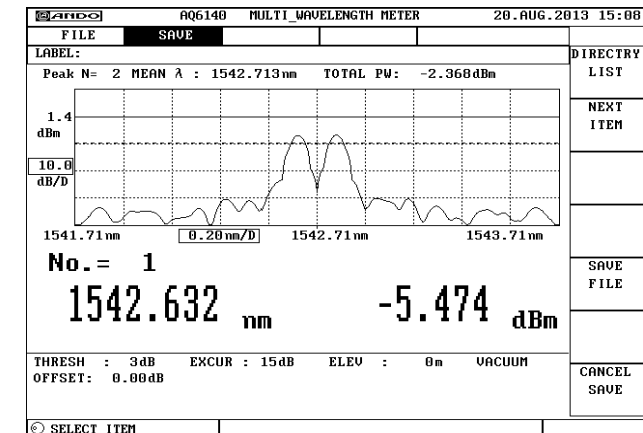
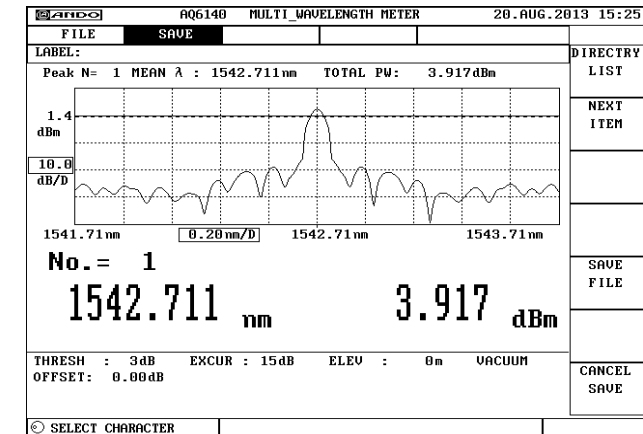
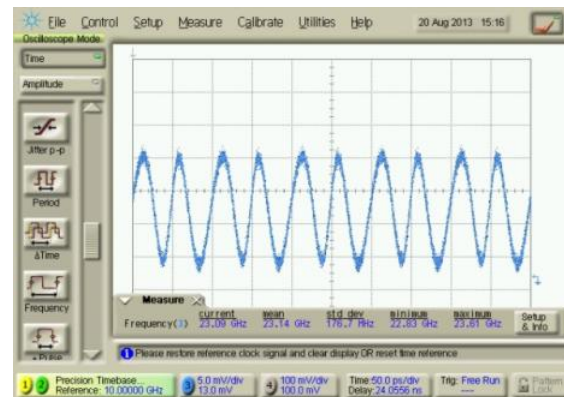
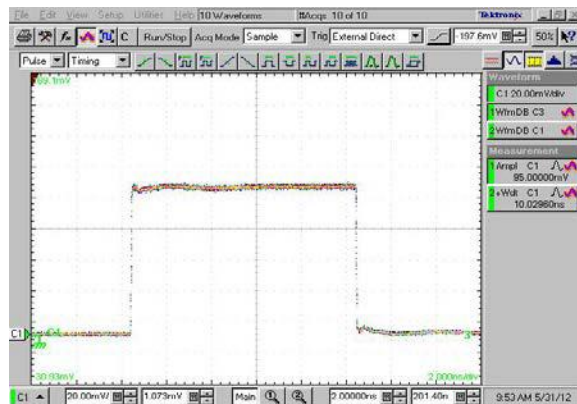

# MXER: Modulator main specification and design

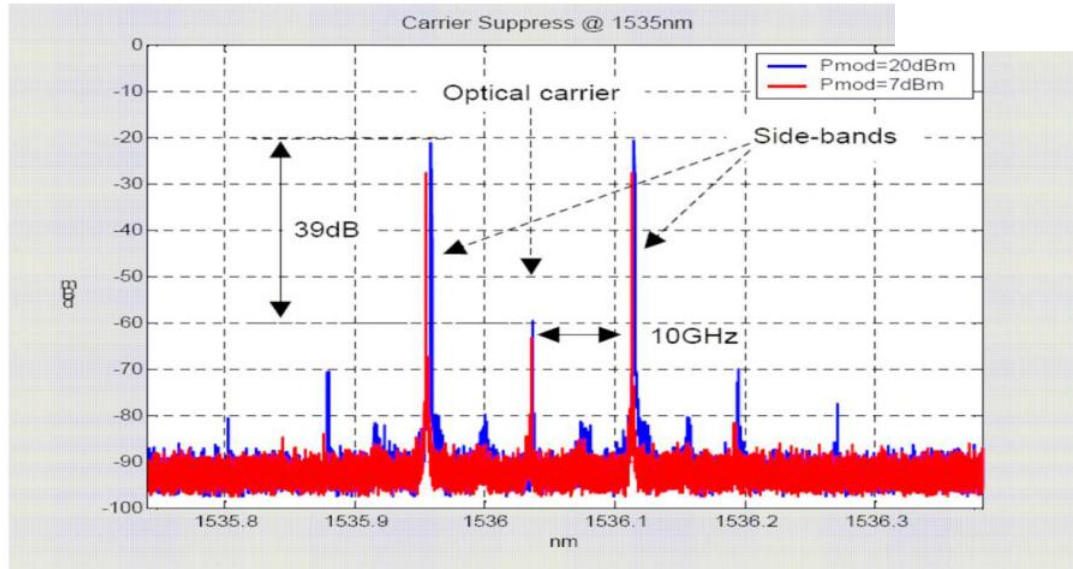

- Carrier suppression  
Using MXER-LN-40dB and MBC-DG

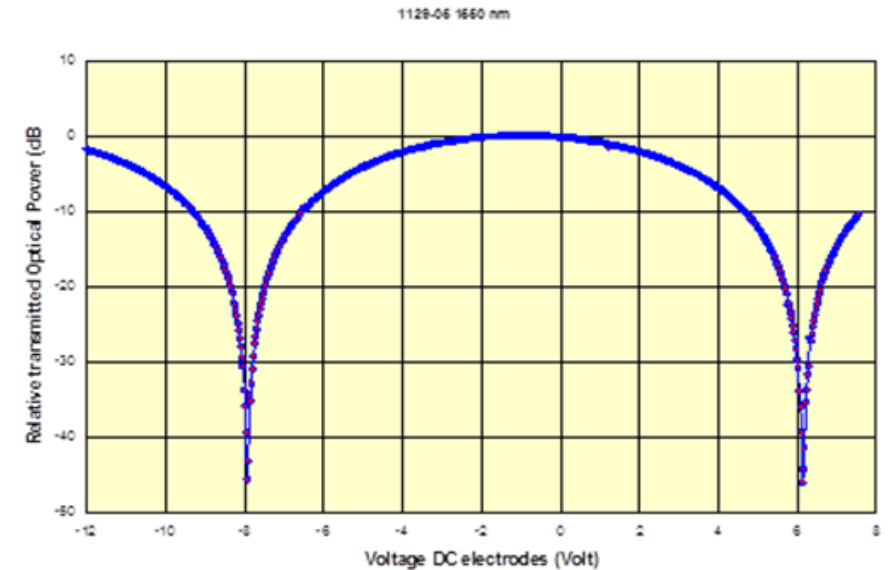

## MXER extinction Ratio

- MXER modulator exhibits high extinction ratio up to 40 dB
- Are available :
  - MXER-LN-10-30dB : SER > 30 dB
  - MXER-LN-10-35dB : SER > 35 dB
  - MXER-LN-10-40dB : SER > 40 dB



# MXER: main specifications

## Electrical Characteristics

Parameter	Symbol	Condition	Min	Typ	Max	Unit
Electro-optic bandwidth	$S_{21}$	RF electrodes, from 2 GHz	10	12	-	GHz
Ripple S21	$\Delta S_{21}$	RF electrodes, $f < 12\text{GHz}$	-	0.5	1	dB
Electrical return loss	$ES_{11}$	RF electrodes	-	-12	-10	dB
$V_{\pi}$ RF @50 kHz	$V_{\pi RF_{50\text{kHz}}}$	RF electrodes	-	5.5	6	V
$V_{\pi}$ RF @10 GHz	$V_{\pi RF_{10\text{GHz}}}$	RF electrodes	-	6.5	7	V
$V_{\pi}$ DC electrodes	$V_{\pi DC}$	DC electrodes	-	6.5	7	V
RF input impedance	$Z_{in-RF}$	-	-	40	-	$\Omega$
DC input impedance	$Z_{in-DC}$	-	1	-	-	$M\Omega$

## Optical Characteristics All specifications given at 25°C, 1550 nm, unless differently specified

Parameter	Symbol	Condition	Min	Typ	Max	Unit
Crystal	-	-	Lithium Niobate X-Cut Y-Prop			
Operating wavelength	$\lambda$	-	1530	1550	1580	nm
Insertion loss	IL	Without connectors	-	4	5	dB
DC extinction ratio	ER > 30	Measured with narrow source linewidth < 200 MHz	30	-	-	dB
	ER > 35		35	-	-	dB
	ER > 40		40	-	-	dB
Optical return loss	ORL	-	-40	-45	-	dB
Chirp	$\alpha$	-	-0.1	0	0.1	-



# MXER: Main characteristics

- Mach-Zehnder modulator insertion loss is -3 dB typically
- Driving voltages are near 5V for the RF and 7V for the DC electrodes
- Electro-optic bandwidth is in the range of 14-18GHz with low electrical S11 return loss
- A high static extinction ratio >40dB is obtained
- Low Vbias drift is obtained thanks to titanium indiffusion process
- High stability of performances with times

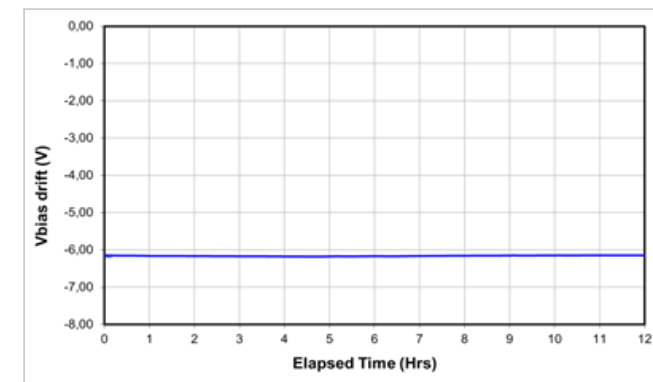
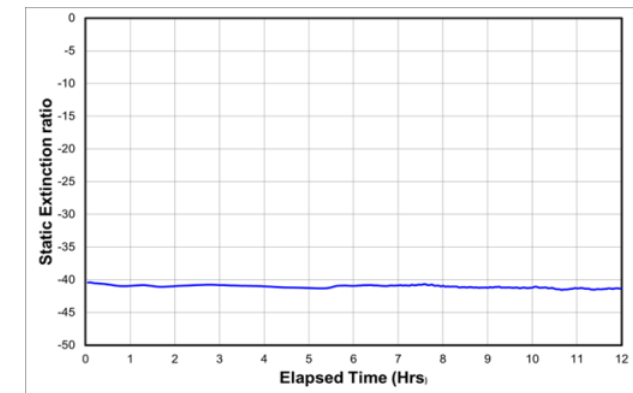
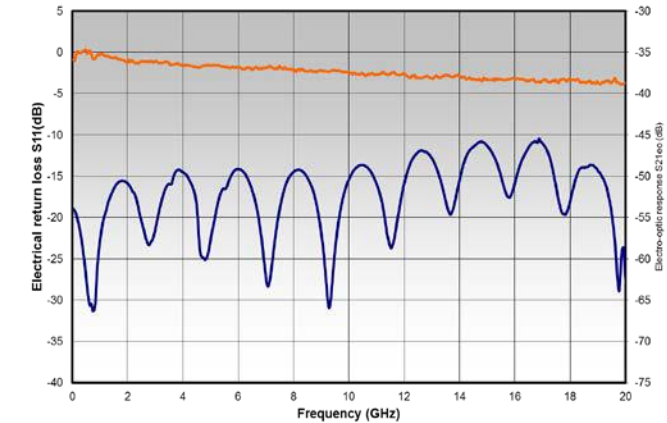

# MXER: qualification: life test

## IL In-situ follow-up

- Ageing: 85°C/ ~5000 h/ Modulators "ON" : equivalent to 25 Years Modulators "ON"
- Note: The modulators were in an operating mode at the following conditions:
- High RF power PRF  $\approx$  +28 dBm at 2.5 GHz
- Popt  $\approx$  +10 dBm

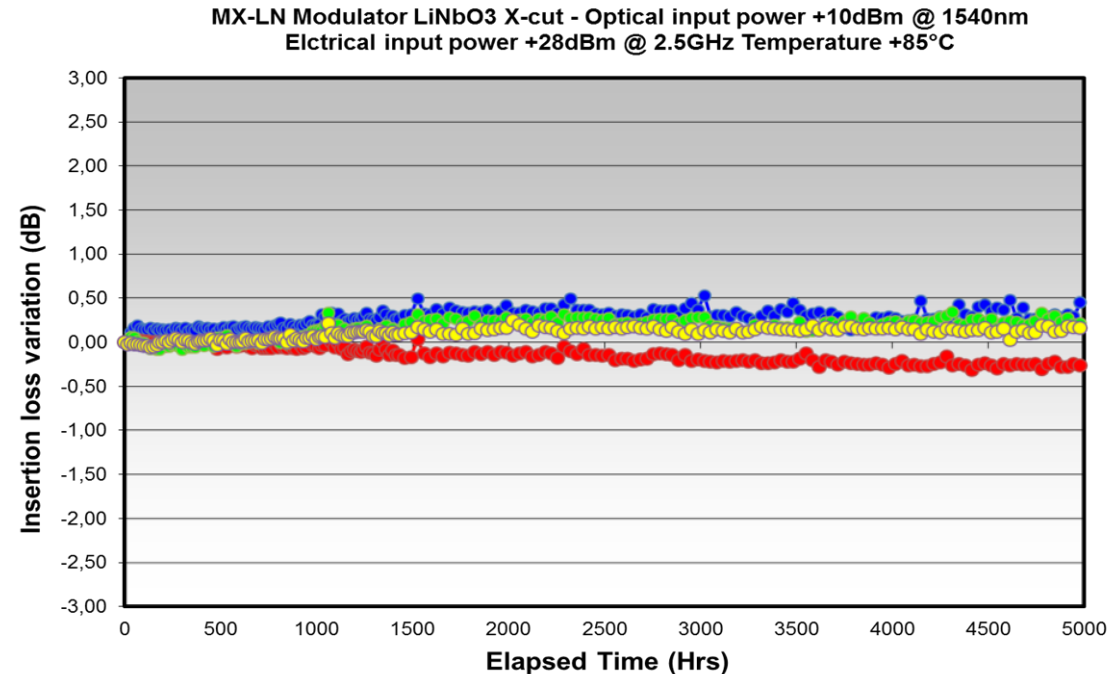

# MXER: Qualification

- Storage condition : The OEM modulator devices are sealed quasi hermetically with neutral and dry gas by seam welding operation.
- The modulator are conditioned in specific carton box with dedicated foam arrangement for fiber.
- An Acceptance test report is joined to the modulator. This document summarize the tracability (serial number), the condition of use and all the measures made on the final component. The document is co-signed by the technician responsible of the measure and the quality manager.



# Modulator Bias Controller

- MBC is a bias controller specially designed to stabilize the operating point of LiNbO<sub>3</sub> Mach-Zehnder modulators by monitoring the bias voltage applied on the DC electrodes of the devices.

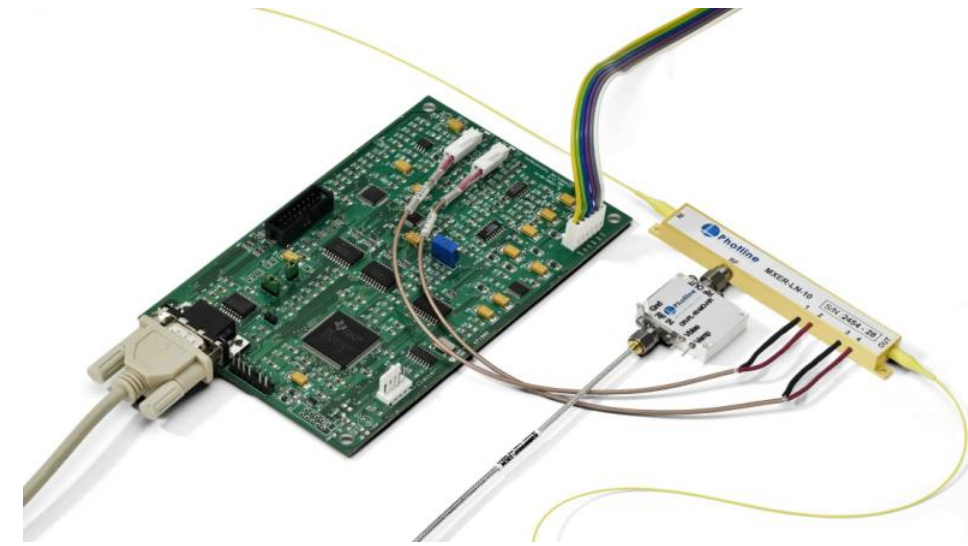

- A Mach-Zehnder modulator is illuminated by a laser at the optical input. The pulse-datas are applied to the RF electrodes. At the output of the MZ modulator, a fiber coupler with a strong imbalance (10:90 or 1:99) allows to detect a small portion of the transmitted light with a monitoring photodiode. The signal is amplified and processed in order to control the stability of the operating point. Any deviation is compensated by a new value of the electrical bias voltage applied by the feedback loop in order to maintain the operating point at the desired position.

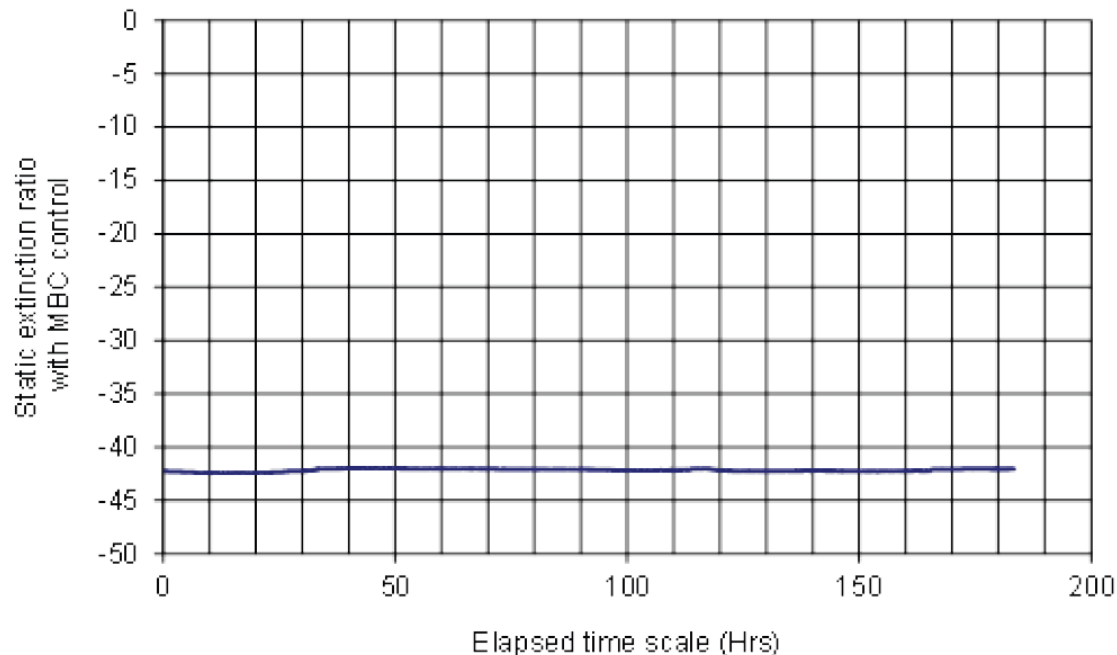

SER Stability using MXER with MBC

MBC controllers lock any modulators at the MIN point of its transfer function.

# MXIQER : Current investigations

- I & Q modulator is currently investigated for BOTDA sensor systems
- Quadrature modulation allows to generate a single side band modulation

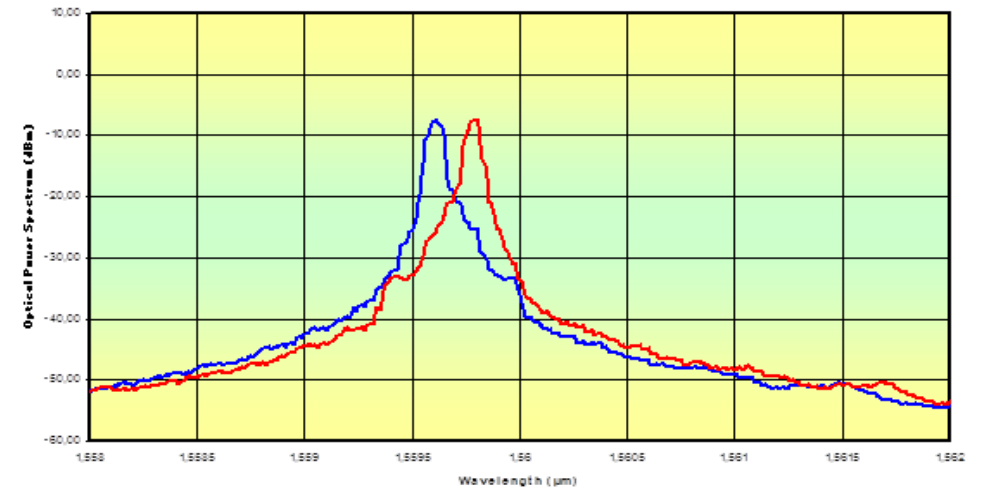
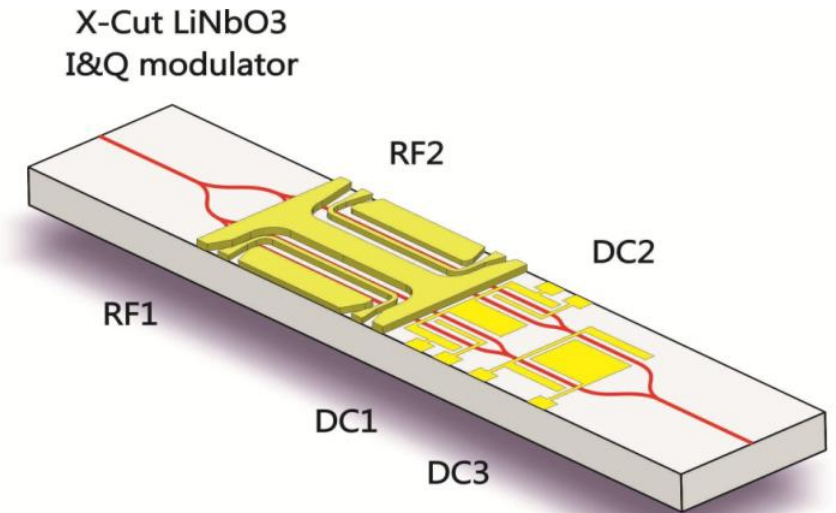
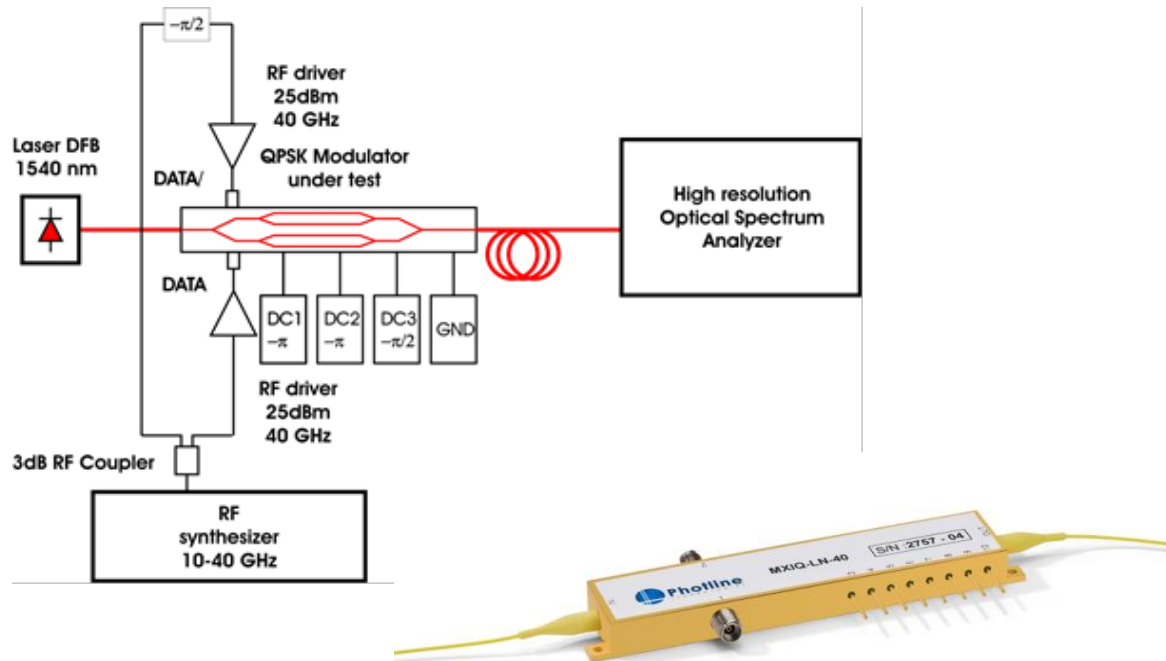

# FBG - Side Band Filter



- The IXC-FBG is a Fiber Bragg Grating UV-printed into an optical fiber.
- Thanks to know-how acquired over the years, iXFiber can supply highly customized FBGs.
- The customer requirements, in terms of spectrum shaping, can be addressed by modifying locally the gratings parameters.
- The gratings can be apodized, phase-shifted and slanted. Bragg wavelength, fiber type and FBG housing are customizable.
- The combination with connectors or a section of specialty fiber can be achieved upon request in order to perform a ready-to-use solution.

**iXblue**