



FEATURES

- High linearity
- Bandwidth > 20 GHz
- High optical stability vs optical power
- Low insertion loss
- High optical input power capability

APPLICATIONS

- RFoF
- Antenna remoting
- Microwave and Radar links
- Overload receiver test

RELATED EQUIPMENTS

- Digital and linear RF amplifiers
- MBC Bias Controllers
- VNA, NRZ, PAM Reference Transmitters

The new MXAN1300-LN-20 modulator design is based on an X-cut crystal etched with an optical waveguide using Annealed Proton Exchange on a selected LiNbO₃ substrate. This fabrication method yields outstanding performance with higher optical input power handling capabilities. Indeed, we guarantee operation with as high as 25 dBm CW optical input without photorefractive limitation effects that could affect the optical insertion loss, extinction ratio stability and modulator drift.

Consistent with the performance and requirements of our MXAN modulators family, the MXAN1300-LN-20 is also a linear modulator for demanding analog transmission links in military and civil applications up to 40 GHz. It features low insertion loss for optimal link gain and high linearity in order to preserve the signal quality.

The MXAN1300-LN-20 is therefore the best candidate for high output power modulated signal solutions using LiNbO₃ waveguide technology. It is especially suitable for microwave links and remote antennas as well as overload receiver tests for the data-com market and modulation schemes such as NRZ-44 Gb/s and PAM4-28 Gbauds.

MXAN1300-LN-20 Performance Highlights

Parameter	Min	Typ	Max	Unit
Operating wavelength	1260	1310	1350	nm
Insertion loss	-	4	5.5	dB
Electro-optical bandwidth	20	25	-	GHz
V _π RF @50 kHz	-	5.5	-	V

Specifications given at 25 °C, 50 Ω, 1310 nm

MXAN1300-LN-20

20 GHz Analog Intensity Modulator

Electrical Characteristics

Parameter	Symbol	Condition	Min	Typ	Max	Unit
Electro-optic bandwidth	S_{21}	RF electrodes, from 2 GHz	20	25	-	GHz
Ripple S_{21}	ΔS_{21}	RF electrodes, $f < 20$ GHz	-	0.5	1	dB
Electrical return loss	S_{11}	RF electrodes, $f < 20$ GHz	-	-13	-9	dB
$V\pi$ RF @ 50 kHz	$V\pi_{RF_{50\text{ kHz}}}$	RF electrodes	-	5.5	6	V
$V\pi$ DC electrodes	$V\pi_{DC}$	DC electrodes	-	4	4.5	V
2 nd harmonic suppression ratio	$H_1 - H_2$	Measured @5 GHz, $RF_{IN} = 0$ dBm	-	60	-	dB
Input 3rd order intercept	IIP3	Measured @5 GHz	28	30	-	dBm
RF input impedance	Z_{in-RF}	-	-	50	-	Ω
DC input impedance	Z_{in-DC}	-	1	-	-	M Ω

 50 Ω RF input

Optical Characteristics

Parameter	Symbol	Condition	Min	Typ	Max	Unit
Crystal	-	-	Lithium Niobate X-Cut Y-Prop			
Operating wavelength	λ	-	1260	1310	1350	nm
Insertion loss	IL	Without connectors	-	4	5.5	dB
DC extinction ratio	ER	Measured with narrow source linewidth < 200 MHz	20	25	-	dB
Optical return loss	ORL	-	-40	-45	-	dB
Chirp	α	-	-0.1	0	+0.1	-

All specifications given at 25°C, 1310 nm, unless differently specified

Absolute Maximum Ratings

Stresses in excess of the absolute maximum ratings can cause permanent damage to the device. These are absolute stress ratings only. Functional operation of the device is not implied at these or any other conditions in excess of those given in the operational sections of the data sheet. Exposure to absolute maximum ratings for extended periods can adversely affect device reliability.

Parameter	Symbol	Min	Max	Unit
RF input power	EP_{in}	-	28	dBm
Bias voltage	V_{bias}	-20	+20	V
Optical input power	OP_{in}	-	25	dBm
Operating temperature	OT	0	+70	°C
Storage temperature	ST	-40	+85	°C

MXAN1300-LN-20 Typical S_{21} Curve

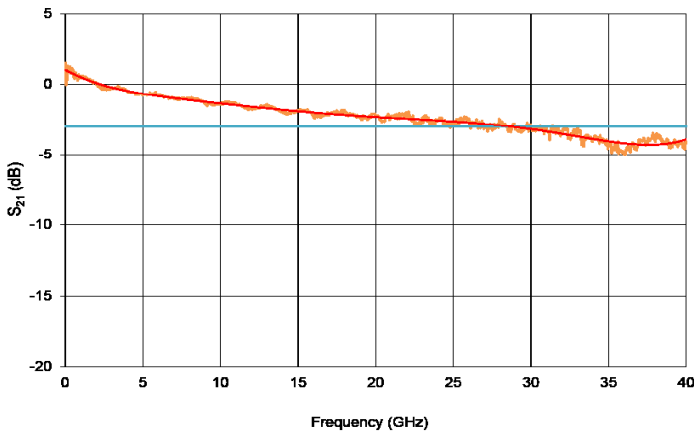

MXAN1300-LN-20 Typical S_{11} Curve

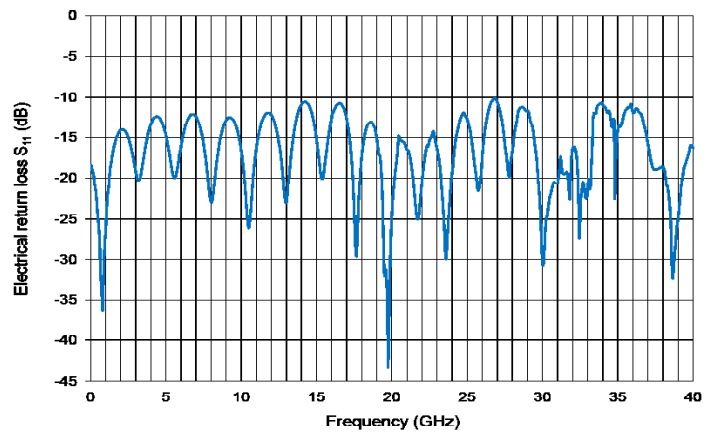

Modulator stability with time @25 °C and 80 mW

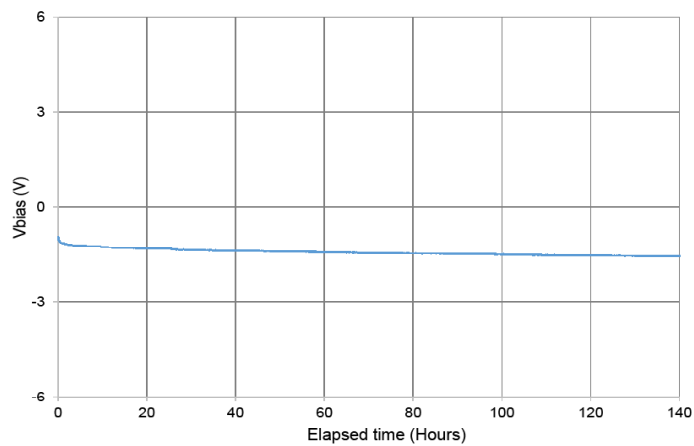

IL & SER stability @25°C and Pin = 300mW

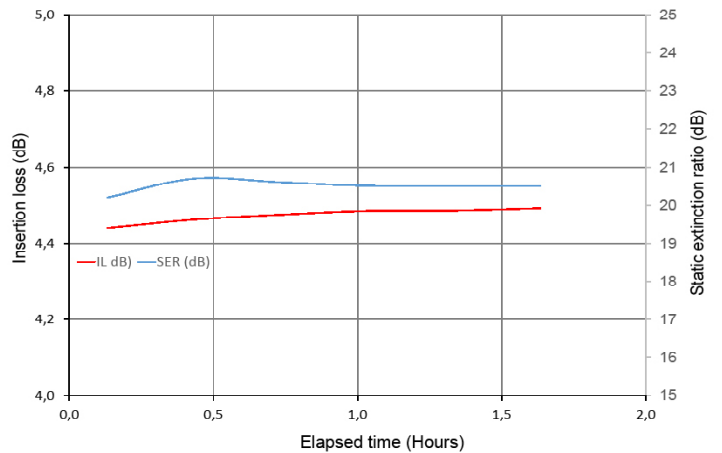

28 Gb/s OOK-NRZ eye diagram

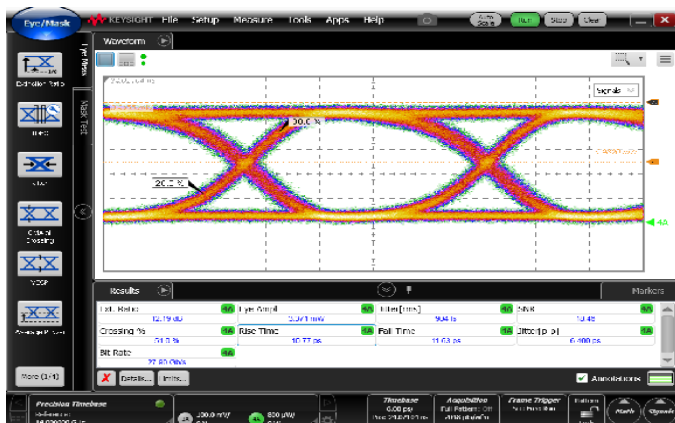

28 Gbauds PAM-4 eye diagram

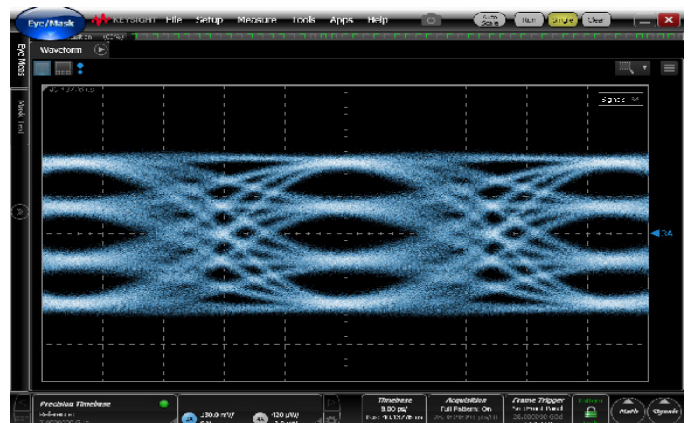

Mechanical Diagram and Pinout

All measurements in mm

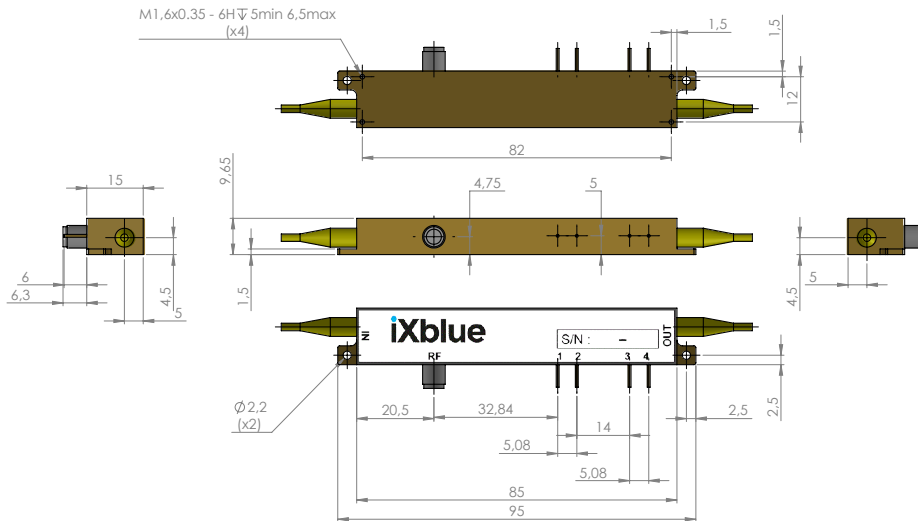

Port	Function	Note
IN	Optical input port	Polarization maintaining fiber, Corning PM 13-U25D, Length 1.5 meter. Buffer diameter 900 mm
OUT	Optical output port	Polarization maintaining fiber, Corning PM 13-U25D, Length 1.5 meter. Buffer diameter 900 mm
RF	RF input port	Female K (V in option)
1	Ground	Pin feed through diameter 1.0 mm
2	DC	Pin feed through diameter 1.0 mm
3, 4	Not connected	Not connected

Ordering information

MXAN1300-LN-20-00-Y-Z-AB-CD

- 00 = No integrated PD
- Y = Input fiber : P Polarization maintaining
- Z = Output fiber : P Polarization maintaining
- AB = Input connector : 00 bare fiber FA FC/APC FC FC/SPC
- CD = Output connector : 00 bare fiber FA FC/APC FC FC/SPC

About us

ixblue Photonics produces specialty optical fibers and Bragg gratings based fiber optics components and provides optical modulation solutions based on the company lithium niobate (LiNbO₃) modulators and RF electronic modules.

ixblue Photonics serves a wide range of industries: sensing and instruments, defense, telecommunications, space and fiber lasers as well as research laboratories all over the world.

3, rue Sophie Germain
25 000 Besançon - FRANCE
Tel. : +33 (0)1 30 08 87 43

ixblue reserves the right to change, at any time and without notice, the specifications, design, function or form of its products described herein. All statements, specification, technical information related to the products herein are given in good faith and based upon information believed to be reliable and accurate at the moment of printing. However the accuracy and completeness thereof is not guaranteed. No liability is assumed for any inaccuracies and as a result of use of the products. The user must validate all parameters for each application before use and he assumes all risks in connection with the use of the products