

## FEATURES

- Output voltage  $6V_{pp}$
- Linear amplifier
- Flat gain up to 30 GHz
- Single voltage power supply
- Low group delay variation

## APPLICATIONS

- LiNbO<sub>3</sub> & InP modulators
- OFDM, RoF, Phase modulation
- Research & Development

## OPTIONS

- Heat-sink
- Low output voltage version for EAM

## RELATED EQUIPMENTS

- MX-LN-40, MXAN-LN-40 modulators
- MBC-AN Automatic Bias Controllers

The DR-AN-40-MO is a wideband RF non-inverting amplifier module designed for analog applications at frequencies up to 40 GHz.

The DR-AN-40-MO is characterized by a low Noise Figure and a linear transfer function whose 1 dB compression point is above 17 dBm. It exhibits flat Group Delay and Gain curves with reduced ripple over the entire bandwidth.

The DR-AN-40-MO operates from a single power supply for safety and ease of use, and offers gain control over 3 dB. It comes in a compact housing with V type RF connectors and with an optional heat-sink.

This amplifier module is ideally suited to drive optical modulators for analog applications.

## Performance Highlights

Parameter	Min	Typ	Max	Unit
Cut-off Frequencies	50 k	-	40 G	Hz
Output Voltage	-	-	6.3	$V_{pp}$
Gain	-	26	-	dB
Saturated Output Power	-	-	20	dBm
Output power 1 dB comp	15	17	-	dBm
Noise Figure	3	-	5	dB

Measurements for  $V_{bias} = 8V$ ,  $V_{amp} = 1.5V$ ,  $V_{xp} = 2.2V$ ,  $I_{bias} = 300mA$

## DC Electrical Characteristics

Parameter	Symbol	Min	Typ	Max	Unit
Supply voltage (fixed)	$V_{bias}$	7	8	9	V
Current consumption	$I_{bias}$	-	300	350	mA
Gain control voltage	$V_{amp}$	0	1.5	1.7	V
Cross point control voltage	$V_{xp}$	0	2.2	2.3	V

## Electrical Characteristics

Parameter	Symbol	Condition	Min	Typ	Max	Unit
Lower frequency	$f_{3db}^{lower}$	-3 dB point	-	-	50	kHz
Upper frequency	$f_{3db}^{upper}$	-3 dB point	36	40	-	GHz
Gain	$S_{21}$	Small signal	-	26	-	dB
Gain ripple	-	< 40 GHz	-	$\pm 1.5$	-	dB
Input return loss	$S_{11}$	50 MHz < f < 30 GHz	-	-10	-	dB
Output return loss	$S_{22}$	50 MHz < f < 30 GHz	-	-10	-	dB
Isolation	$S_{12}$	50 MHz < f < 30 GHz	-	-60	-	dB
Output power 1 dB	$P_{1dB}$	2 GHz < f < 20 GHz	15	17	-	dBm
Saturated power	$P_{sat}$	f < 20 GHz	-	20	-	dBm
Output voltage	$V_{out}$	Linear	0	4.5	-	$V_{pp}$
		Maximum swing	0	6.3	-	
Noise figure	NF	f < 1 GHz	5	-	-	dB
		1 GHz < f < 26 GHz	3	-	5	
Power dissipation	P	-	-	2.4	3.2	W

Conditions:  $V_{in} = 0.5 V_{pp}$ ,  $T_{amb} = 25^\circ\text{C}$ , 50  $\Omega$  system

## Absolute Maximum Ratings

Stresses in excess of the absolute maximum ratings can cause permanent damage to the device. These are absolute stress ratings only. Functional operation of the device is not implied at these or any other conditions in excess of those given in the operational sections of the data sheet. Exposure to absolute maximum ratings for extended periods can adversely affect device reliability.

Parameter	Symbol	Min	Max	Unit
RF input voltage	$V_{in}$	-	0.63	$V_{pp}$
Supply Voltage	$V_{bias}$	0	9	V
DC current	$I_{bias}$	0	350	mA
Gain control voltage	$V_{amp}$	0	1.7	V
Output power control voltage	$V_{xp}$	0	2.3	V
Power dissipation	$P_{diss}$	-	3.2	W
Temperature of operation	$T_{op}$	0	+50	$^\circ\text{C}$
Storage temperature	$T_{st}$	-20	+70	$^\circ\text{C}$

**$S_{21}$  and Group Delay Parameter Curve**

Conditions:  $V_{bias} = 8\text{ V}$ ,  $V_{amp} = 1.5\text{ V}$ ,  $V_{xp} = 2.2\text{ V}$ ,  $I_{bias} = 300\text{ mA}$

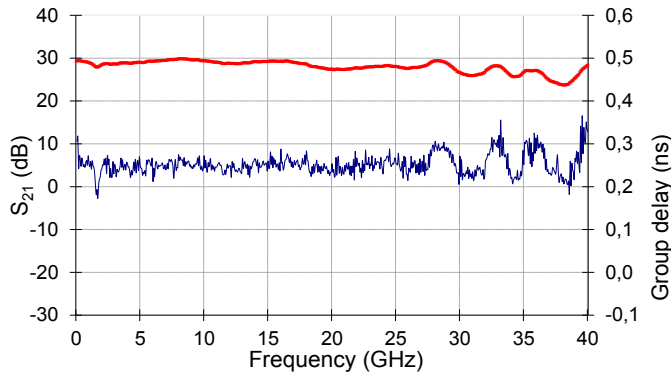

**$S_{12}$  Parameter Curve**

Conditions:  $V_{bias} = 8\text{ V}$ ,  $V_{amp} = 1.5\text{ V}$ ,  $V_{xp} = 2.2\text{ V}$ ,  $I_{bias} = 300\text{ mA}$

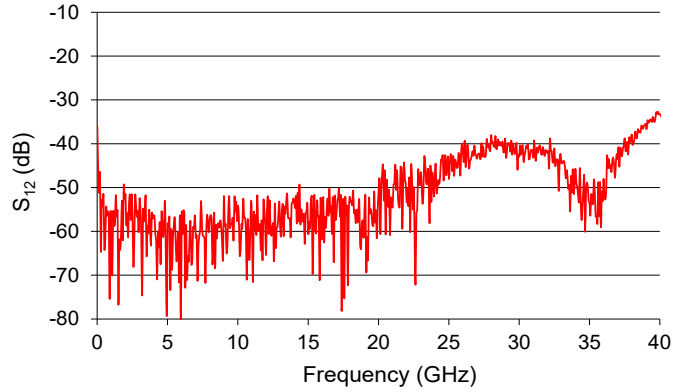

**$S_{22}$  Parameter Curve**

Conditions:  $V_{bias} = 8\text{ V}$ ,  $V_{amp} = 1.5\text{ V}$ ,  $V_{xp} = 2.2\text{ V}$ ,  $I_{bias} = 300\text{ mA}$

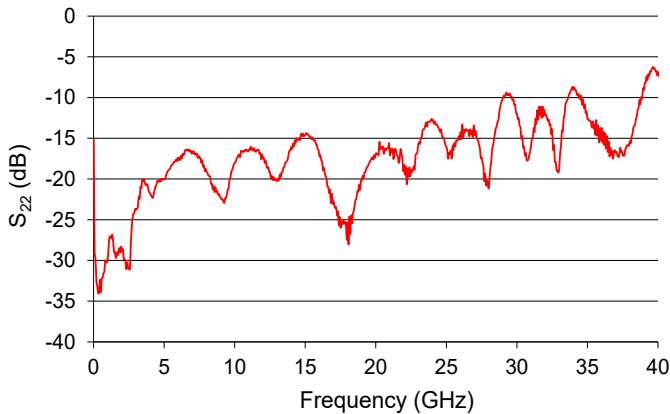

**$S_{11}$  Parameter Curve**

Conditions:  $V_{bias} = 8\text{ V}$ ,  $V_{amp} = 1.5\text{ V}$ ,  $V_{xp} = 2.2\text{ V}$ ,  $I_{bias} = 300\text{ mA}$

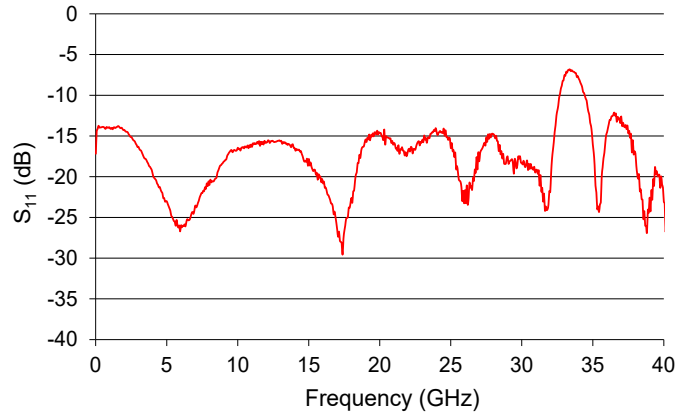

**Saturated Output Power Curve**

Conditions:  $V_{bias} = 8\text{ V}$ ,  $V_{amp} = 1.5\text{ V}$ ,  $V_{xp} = 2.2\text{ V}$ ,  $I_{bias} = 300\text{ mA}$

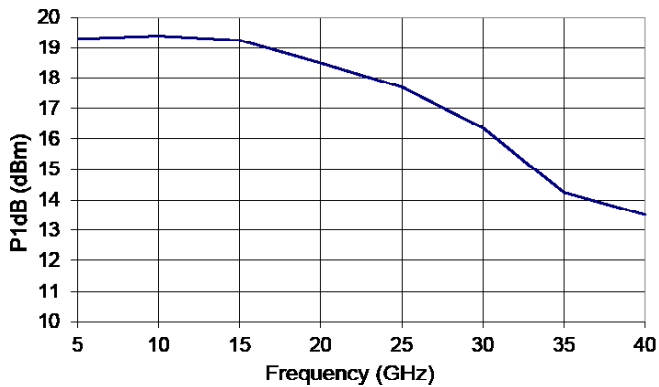

**Noise Figure Curve**

Conditions:  $V_{bias} = 8\text{ V}$ ,  $V_{amp} = 1.5\text{ V}$ ,  $V_{xp} = 2.2\text{ V}$ ,  $I_{bias} = 300\text{ mA}$

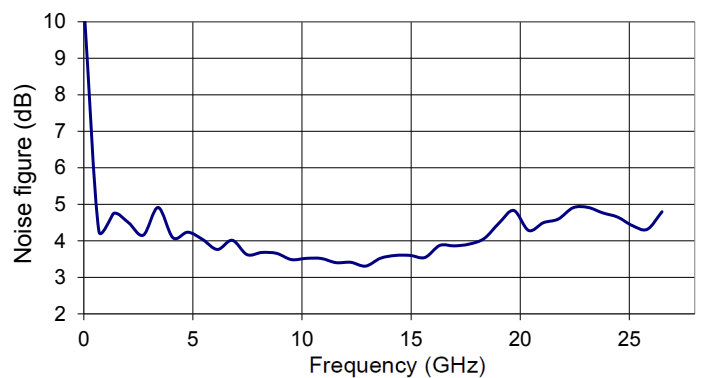

Electrical Schematic Diagram

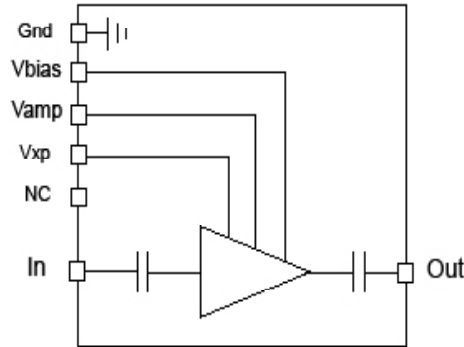

Mechanical Diagram and Pinout

All measurements in mm

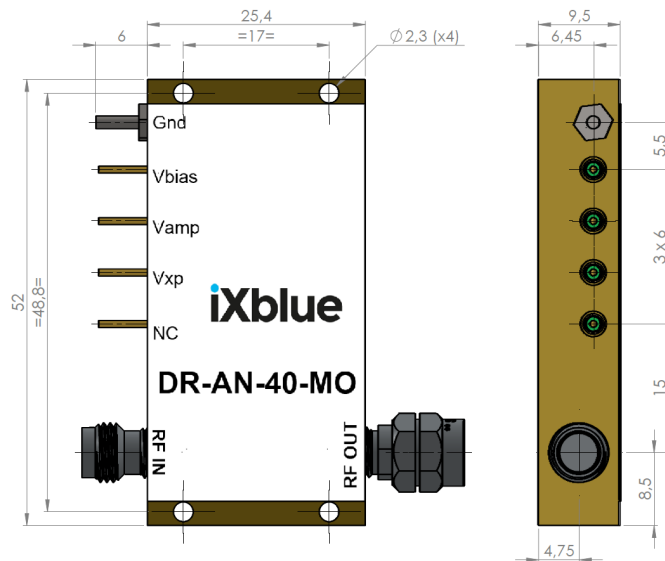

The heat-sinking of the module is necessary. It's user responsibility to use an adequate heat-sink. Refer to page 6 for ixblue recommended heat-sink.

PIN	Function	Unit
IN	RF In	V connector female
OUT	RF Out	V connector male
$V_{bias}$	Power supply voltage	Set a typical operating specification
$V_{amp}$	Output voltage amplitude adjustment	Adjust for gain control tuning
$V_{xp}$	Output power adjustment	Adjust for power tuning

Mechanical Diagram And Pinout With HS-MO4 Heat-sink

All measurements in mm

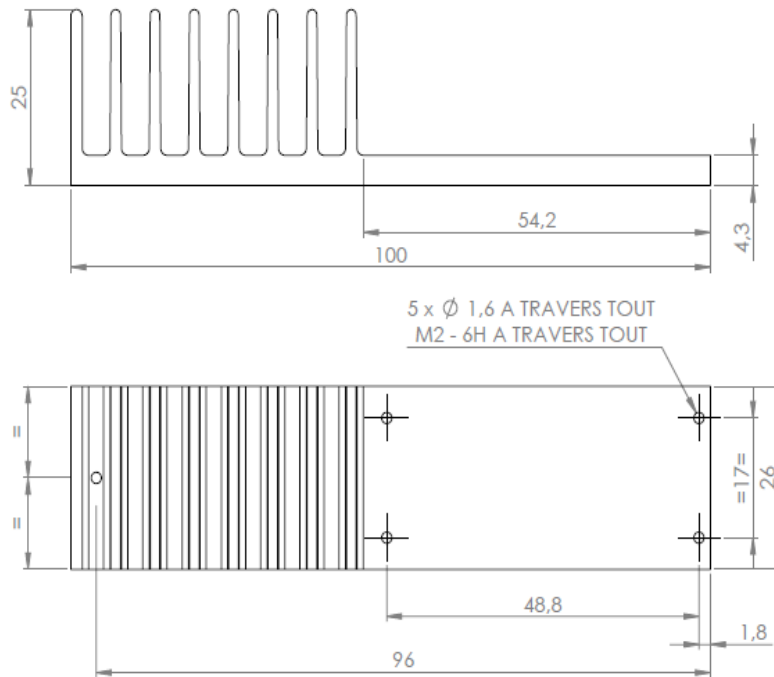
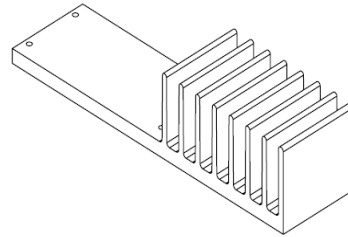

About us

ixblue Photonics produces specialty optical fibers and Bragg gratings based fiber optics components and provides optical modulation solutions based on the company lithium niobate (LiNbO<sub>3</sub>) modulators and RF electronic modules.

ixblue Photonics serves a wide range of industries: sensing and instruments, defense, telecommunications, space and fiber lasers as well as research laboratories all over the world.