

FEATURES

- Output voltage up to 9 V_{pp}
- Linear amplifier
- Flat gain up to 12 GHz
- Single voltage power supply
- Low group delay variation

APPLICATIONS

- LiNbO₃ modulators
- OFDM, RF over fiber
- Linear amplification
- Clock amplifier
- Research & Development

OPTIONS

- Heat-sink

The DR-AN-10-MO is a wideband RF amplifier module designed for analog applications at frequencies up to 12 GHz.

The DR-AN-10-MO is characterized by a low Noise Figure and a linear transfer function whose 1 dB compression point is above 21 dBm. It exhibits flat Group Delay and Gain curves with reduced ripple over the entire bandwidth.

The DR-AN-10-MO comes in a compact 52 mm x 25.6 mm housing with K type RF connectors (compatible SMA) and with an optional heat-sink. It operates from a single power supply for safety and ease of use, and offers gain control over 3 dB.

This amplifier module is ideally suited to drive optical modulators for analog applications.

Performance Highlights

Parameter	Min	Typ	Max	Unit
Cut-off frequencies	50 k	11 G	-	Hz
Output voltage	0	-	9	V _{pp}
Gain	28	30	-	dB
Saturated output power	23	-	-	dBm
Output power 1dB comp	21	22	-	dB
Harmonics	-	-	-15	dBc
Noise Figure	3	-	6	dB

Measurements for V_{bias} = 12 V, V_{amp} = 1.2 V, I_{bias} = 310 mA

DC Electrical Characteristics

Parameter	Symbol	Min	Typ	Max	Unit
Supply voltage (fixed)	V_{bias}	-	12	13	V
Current consumption	I_{bias}	-	300	400	mA
Gain control voltage	V_{amp}	-	1.2	1.3	V

Electrical Characteristics

Parameter	Symbol	Condition	Min	Typ	Max	Unit
Lower frequency	f_{3dB} lower	-3 dB point	50	-	-	kHz
Upper frequency	f_{3dB} upper	-3 dB point	-	11	-	GHz
Gain	S_{21}	Small signal, $f < 10$ GHz	28	30	-	dB
Gain ripple	-	$f < 10$ GHz	-	-	± 1.5	dB
Input return loss	S_{11}	$f < 10$ GHz	-	-10	-	dB
Output return loss	S_{22}	$f < 10$ GHz	-	-15	-	dB
Isolation	S_{12}	$f < 10$ GHz	-	-60	-	dB
Output power 1dB	P_{1dB}	$2 \text{ GHz} < f < 10 \text{ GHz}$	21	22	-	dBm
Saturated output power	P_{sat}	$2 \text{ GHz} < f < 10 \text{ GHz}$	23	-	-	dBm
Output voltage	V_{out}	Linear	0	-	7	V_{pp}
		Maximum swing	0	-	9	
Noise Figure	NF	$2 \text{ GHz} < f < 10 \text{ GHz}$	3	-	6	dB
Harmonics	Harm	@ P_{1dB} , $f < 5 \text{ GHz}$	-	-	-15	dBc
Power dissipation	P	Small signal	-	3.6	5.2	W

Conditions: S parameters conditions : $P_{in} = -30 \text{ dBm}$, $T_{amb} = 25 \text{ }^\circ\text{C}$, $50 \text{ } \Omega$ system

Absolute Maximum Ratings

Stresses in excess of the absolute maximum ratings can cause permanent damage to the device. These are absolute stress ratings only. Functional operation of the device is not implied at these or any other conditions in excess of those given in the operational sections of the data sheet. Exposure to absolute maximum ratings for extended periods can adversely affect device reliability.

Parameter	Symbol	Min	Max	Unit
RF input voltage	V_{in}	-	0.6	V_{pp}
Supply voltage	V_{bias}	0	13	V
DC current	I_{bias}	0	400	mA
Gain control voltage	V_{amp}	0	1.3	V
Power dissipation	P_{diss}	-	5.2	W
Temperature of operation	T_{op}	0	+50	$^\circ\text{C}$
Storage temperature	T_{st}	-10	+70	$^\circ\text{C}$

S_{21} and Group Delay Parameter Curves

Conditions: $V_{bias} = 12\text{ V}$, $V_{amp} = 1.2\text{ V}$, $I_{bias} = 310\text{ mA}$

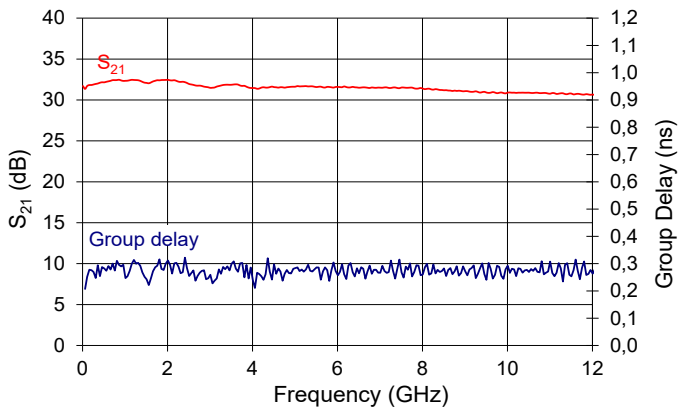

S_{12} Parameter Curve

Conditions: $V_{bias} = 12\text{ V}$, $V_{amp} = 1.2\text{ V}$, $I_{bias} = 310\text{ mA}$

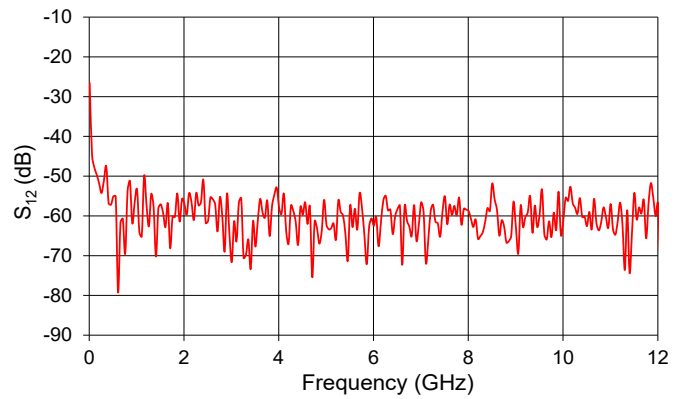

S_{22} Parameter Curve

Conditions: $V_{bias} = 12\text{ V}$, $V_{amp} = 1.2\text{ V}$, $I_{bias} = 310\text{ mA}$

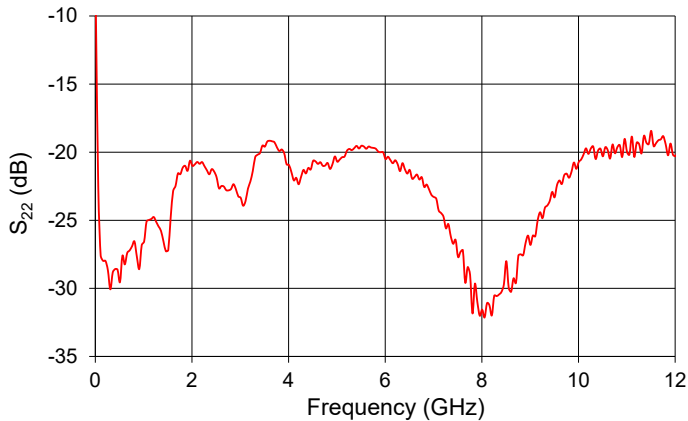

S_{11} Parameter Curve

Conditions: $V_{bias} = 12\text{ V}$, $V_{amp} = 1.2\text{ V}$, $I_{bias} = 310\text{ mA}$

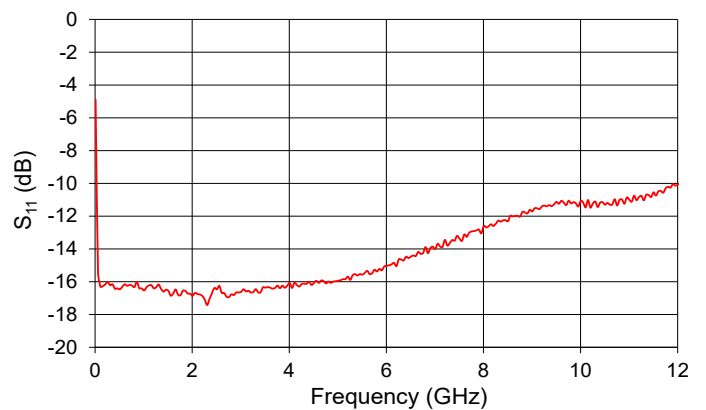

Saturated Output Power Curve

Conditions: $V_{bias} = 12\text{ V}$, $V_{amp} = 1.2\text{ V}$, $I_{bias} = 310\text{ mA}$

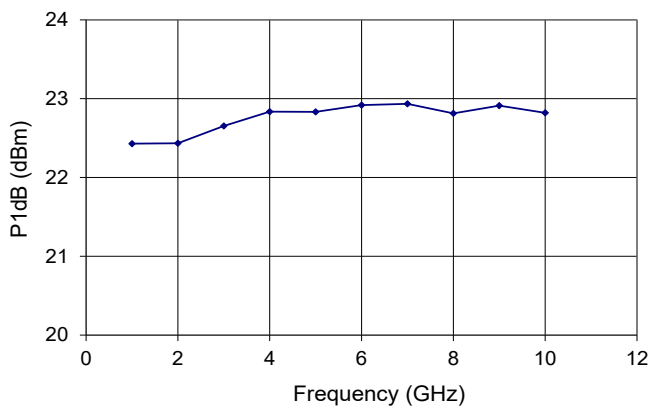

Noise Figure Curve

Conditions: $V_{bias} = 12\text{ V}$, $V_{amp} = 1.2\text{ V}$, $I_{bias} = 310\text{ mA}$

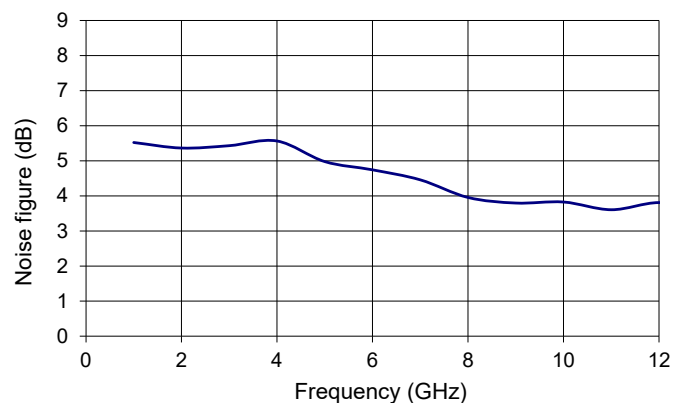

Electrical Schematic Diagram

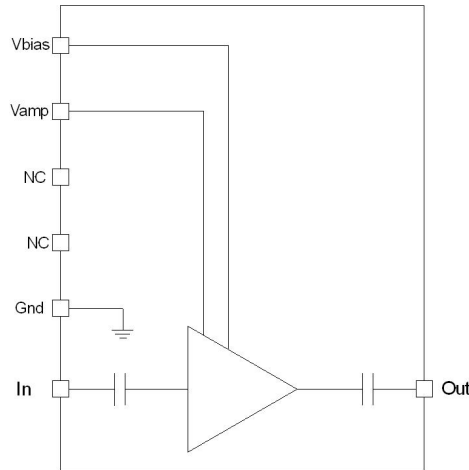

Mechanical Diagram and Pinout
All measurements in mm

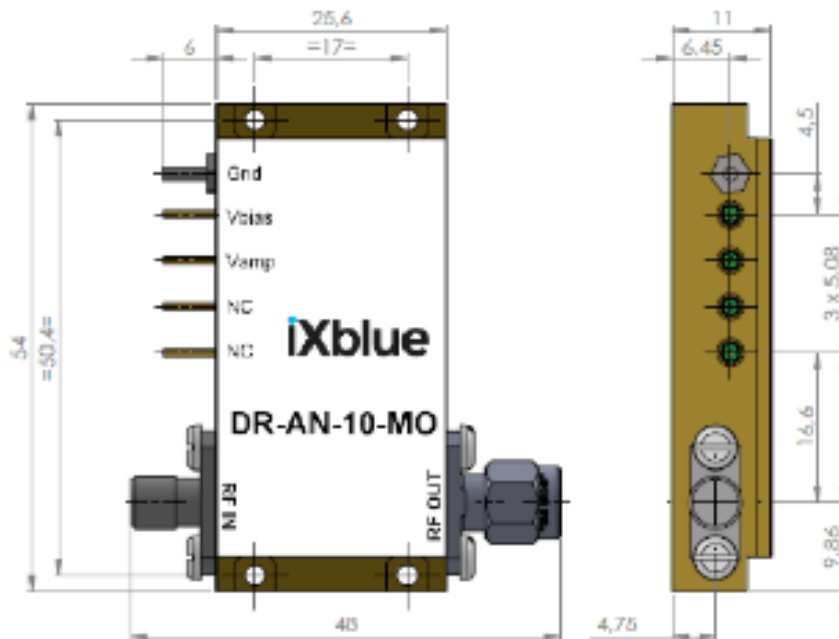

The heat-sinking of the module is necessary. It's user responsibility to use an adequate heat-sink. Refer to page 5 for ixblue recommended heat-sink.

PIN	Function	Operational Notes
IN	RF In	K-connector female
OUT	RF Out	K-connector male
V_{bias}	Power supply voltage	Set at typical operating specification
V_{amp}	Output voltage amplitude adjustment	Adjust for gain control tuning

Mechanical Diagram and Pinout with HS-MO2 Heat-sink
All measurements in mm

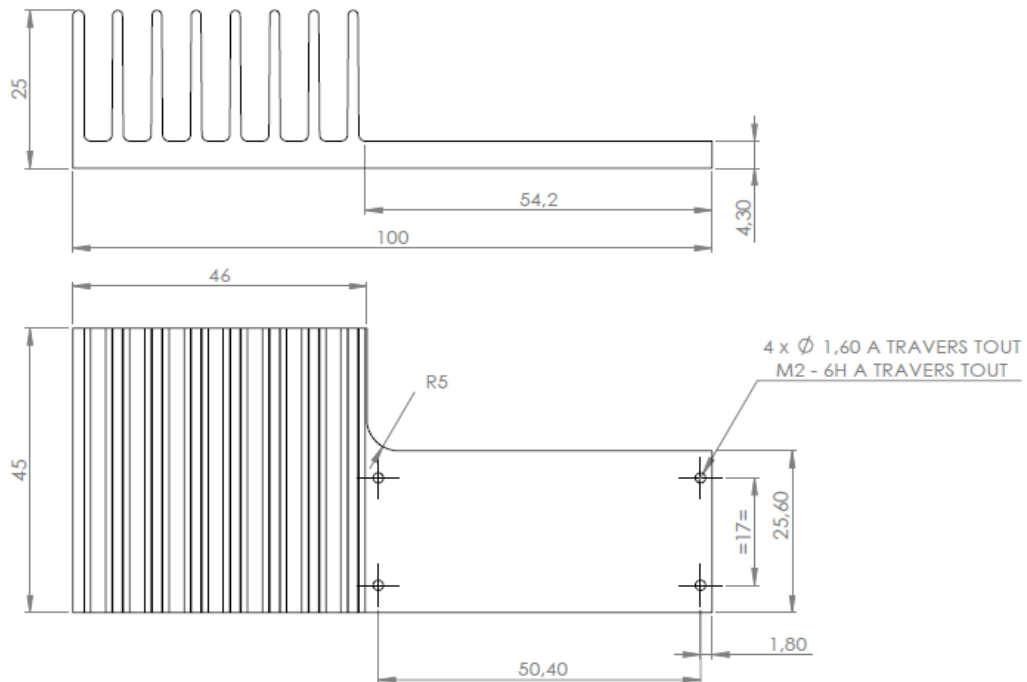
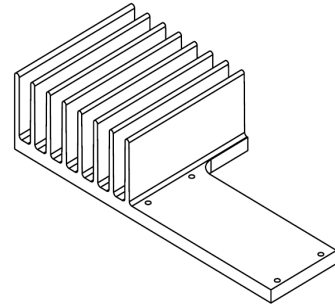

About us

ixblue Photonics produces specialty optical fibers and Bragg gratings based fiber optics components and provides optical modulation solutions based on the company lithium niobate (LiNbO₃) modulators and RF electronic modules.

ixblue Photonics serves a wide range of industries: sensing and instruments, defense, telecommunications, space and fiber lasers as well as research laboratories all over the world.

3, rue Sophie Germain
25 000 Besançon - FRANCE
Tel. : +33 (0)1 30 08 87 43

ixblue reserves the right to change, at any time and without notice, the specifications, design, function or form of its products described herein. All statements, specification, technical information related to the products herein are given in good faith and based upon information believed to be reliable and accurate at the moment of printing. However the accuracy and completeness thereof is not guaranteed. No liability is assumed for any inaccuracies and as a result of use of the products. The user must validate all parameters for each application before use and he assumes all risks in connection with the use of the products