

FEATURES

- Output voltage up to 15.9 V_{pp}
- Linear amplifier
- Flat gain up to 10 GHz
- Single voltage power supply
- Low group delay variation

APPLICATIONS

- Radio Over Fiber
- Frequency-comb
- Spectrum broadening

OPTIONS

- Heat-sink

RELATED EQUIPMENTS

- MXIQER, MXAN, phase modulators

The DR-AN-10-HO is a wideband RF amplifier module designed for analog applications at frequencies up to 10 GHz.

The DR-AN-10-HO is characterized by a low Noise Figure and a linear transfer function whose 1 dB compression point is above 25 dBm. It exhibits flat Group Delay and Gain curves with reduced ripple over the entire bandwidth.

The DR-AN-10-HO operates from a single power supply for safety and ease of use, and offers gain control over 3 dB. It comes in a compact 52 mm x 25.6 mm housing with K type RF connectors (compatible SMA) and with an optional heat-sink.

This amplifier module is ideally suited to drive optical modulators for analog and linear applications.

Performance Highlights

Parameter	Min	Typ	Max	Unit
Cut-off frequencies	80 k	11 G	-	Hz
Output voltage	0	-	15.9	V _{pp}
Gain	-	27	-	dB
Saturated output power	27	28	-	dBm
Output power 1dB comp	25	26	-	dBm
Harmonics	-	-	-15	dBc
Noise figure	-	-	3	dB

Measurements for V_{bias} = 12 V, V_{amp} = 1.5 V, I_{bias} = 410mA

DC Electrical Characteristics

Parameter	Symbol	Min	Typ	Max	Unit
Supply voltage (fixed)	V_{bias}	11	12	13	V
Current consumption	I_{bias}	-	410	450	mA
Gain control voltage	V_{amp}	-	1.5	2	V

Electrical Characteristics

Parameter	Symbol	Condition	Min	Typ	Max	Unit
Lower frequency	f_{3dB} lower	-3 dB point	-	-	80	kHz
Upper frequency	f_{3dB} upper	-3 dB point	10	11	-	GHz
Gain	S_{21}	Small signal	25	27	-	dB
Gain ripple	-	< 10 GHz	-	-	± 1.5	dB
Input return loss	S_{11}	$f < 10$ GHz	-	-	-10	dB
Output return loss	S_{22}	$f < 10$ GHz	-	-	-10	dB
Isolation	S_{12}	$f < 10$ GHz	-	-	-60	dB
Output power 1 dB	P_{1dB}	$2 \text{ GHz} < f < 10 \text{ GHz}$	25	26	-	dBm
Saturated power	P_{sat}	$2 \text{ GHz} < f < 10 \text{ GHz}$	27	28	-	dBm
Output voltage	V_{out}	Linear	0	-	10	V_{pp}
		Maximum swing	0	-	15.9	
Noise figure	NF	$3 \text{ GHz} < f < 10 \text{ GHz}$	-	-	3	dB
Harmonics	Harm	P_{1dB} , $f = 5 \text{ GHz}$	-	-	-15	dBc
Power dissipation	P	Small signal	-	4.9	-	W

Conditions: S parameters -30 dBm, $T_{amb} = 25^\circ\text{C}$, 50 Ω system

Absolute Maximum Ratings

Stresses in excess of the absolute maximum ratings can cause permanent damage to the device. These are absolute stress ratings only. Functional operation of the device is not implied at these or any other conditions in excess of those given in the operational sections of the data sheet. Exposure to absolute maximum ratings for extended periods can adversely affect device reliability.

Parameter	Symbol	Min	Max	Unit
RF input voltage	V_{in}	-	0.9	V_{pp}
Supply Voltage	V_{bias}	11	13	V
DC current	I_{bias}	-	450	mA
Gain control voltage	V_{amp}	0	2	V
Power dissipation	P_{diss}	-	5.8	W
Temperature of operation	T_{op}	0	+40	$^\circ\text{C}$
Storage temperature	T_{st}	10	+70	$^\circ\text{C}$

S₂₁ Parameter Curve

Conditions: $V_{bias} = 12\text{ V}$, $V_{amp} = 1.5\text{ V}$, $I_{bias} = 410\text{ mA}$

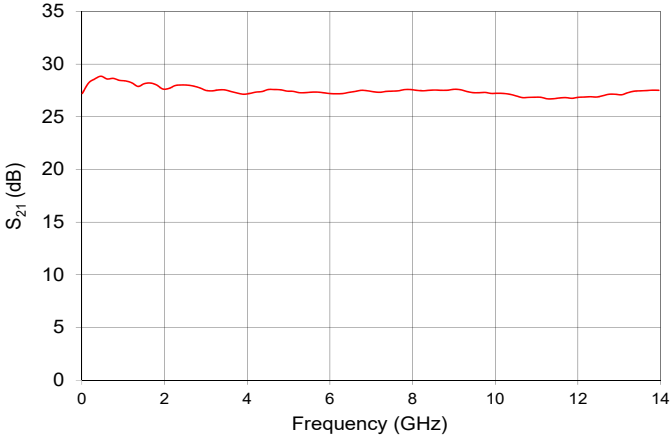

Group Delay Parameter Curve

Conditions: $V_{bias} = 12\text{ V}$, $V_{amp} = 1.5\text{ V}$, $I_{bias} = 410\text{ mA}$

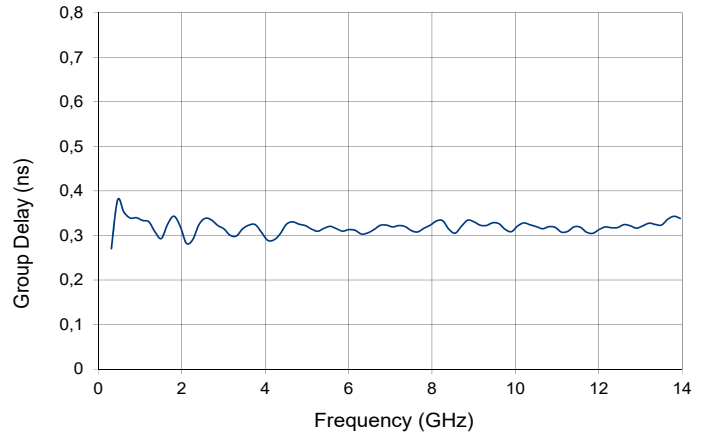

S₂₂ Parameter Curve

Conditions: $V_{bias} = 12\text{ V}$, $V_{amp} = 1.5\text{ V}$, $I_{bias} = 410\text{ mA}$

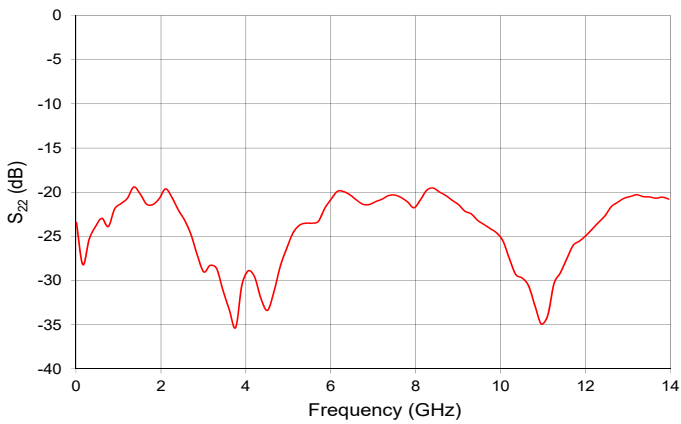

S₁₁ Parameter Curve

Conditions: $V_{bias} = 12\text{ V}$, $V_{amp} = 1.5\text{ V}$, $I_{bias} = 410\text{ mA}$

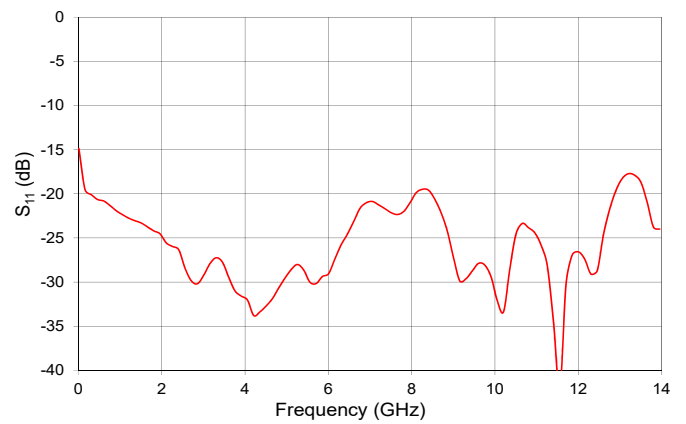

P_{out} @ 1dB compression Curve

Conditions: $V_{bias} = 12\text{ V}$, $V_{amp} = 1.5\text{ V}$, $I_{bias} = 410\text{ mA}$

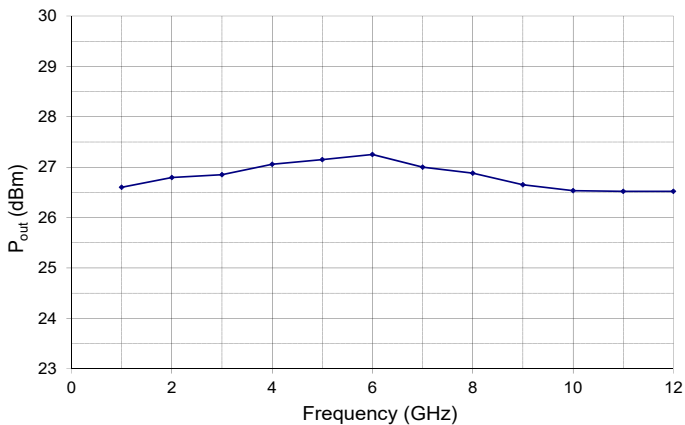

Noise Figure Curve

Conditions: $V_{bias} = 12\text{ V}$, $V_{amp} = 1.5\text{ V}$, $I_{bias} = 410\text{ mA}$

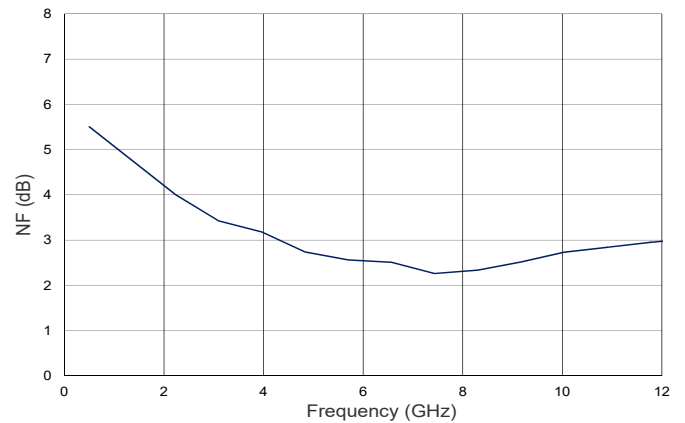

Electrical Schematic Diagram

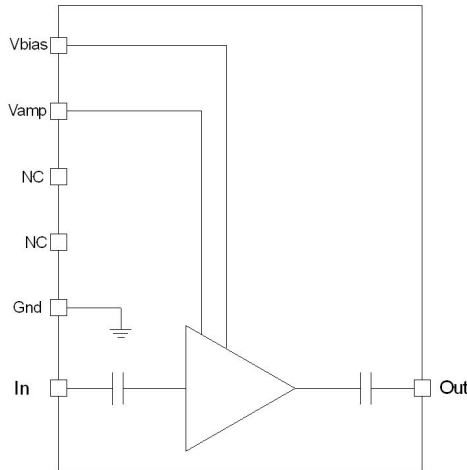

Mechanical Diagram and Pinout

All measurements in mm

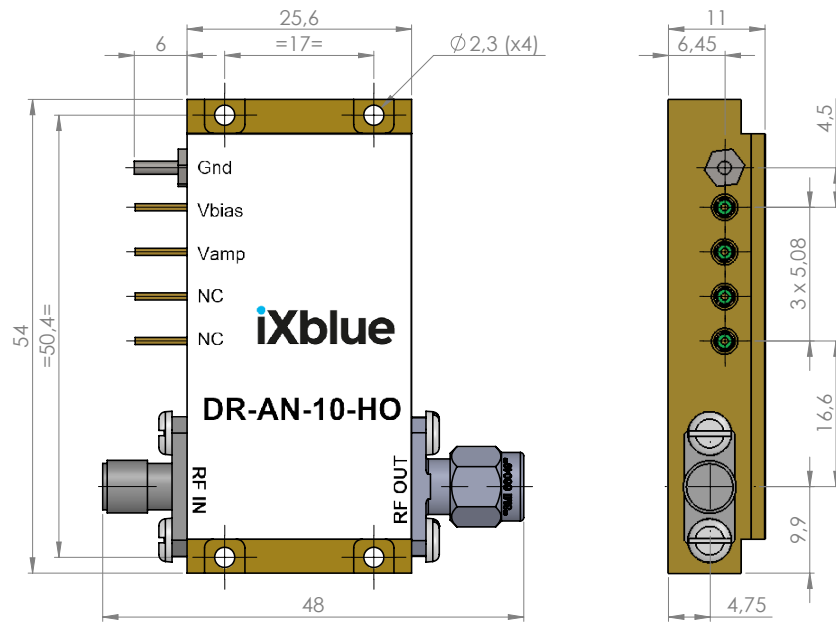

The heat-sinking of the module is necessary. It's user responsibility to use an adequate heat-sink. Refer to page 5 for ixblue recommended heat-sink.

PIN	Function	Unit
IN	RF In	Kconnector female
OUT	RF Out	K connector male
V_{bias}	Power supply voltage	Set a typical operating specification
V_{amp}	Output voltage amplitude adjustment	Adjust for gain control tuning

Mechanical Diagram And Pinout With HS-HO1 Heat-sink

All measurements in mm

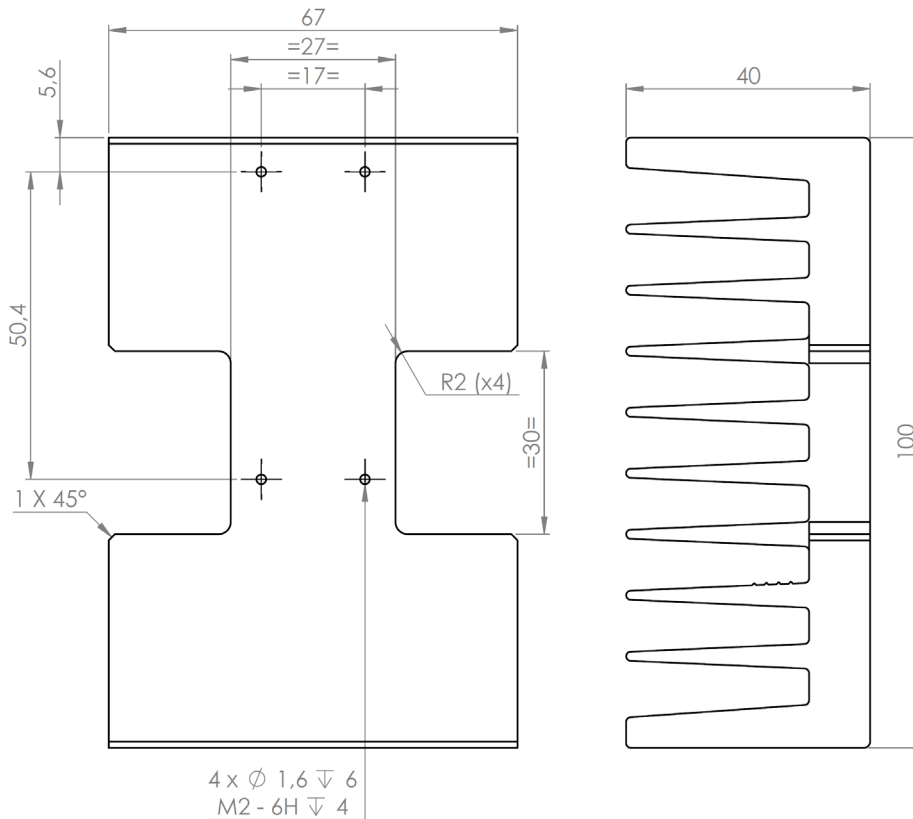
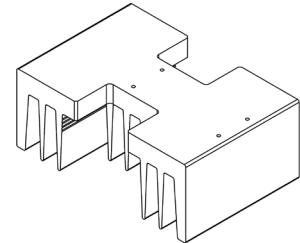

About us

ixblue Photonics produces specialty optical fibers and Bragg gratings based fiber optics components and provides optical modulation solutions based on the company lithium niobate (LiNbO₃) modulators and RF electronic modules.

ixblue Photonics serves a wide range of industries: sensing and instruments, defense, telecommunications, space and fiber lasers as well as research laboratories all over the world.