

FEATURES

- Output voltage up to 9 V_{pp}
- Low Rise/Fall time
- Flat gain up to 15 GHz
- Single voltage power supply
- Low group delay variation

APPLICATIONS

- LiNbO₃ modulators
- 12.5 Gbps NRZ and RZ
- OC-192 SONET / SDH
- Research & Development

OPTIONS

- Heat-sink

The DR-DG-12-MO is a high performance versatile driver module designed for 2.5 Gbps up to 12.5 Gbps data transmission with NRZ or RZ format. It exhibits a 28 dB gain and can deliver an output signal up to 9 V_{pp}.

The DR-DG-12-MO is a key component to obtain high quality 2.5 Gbps up to 12.5 Gbps eye diagrams with low rise and fall time, low jitter and high SNR. It operates from a single power supply for safety and ease of use, and offers gain and cross point controls. It comes with K type RF connectors (female in, male out) and with an optional heat sink.

Performance Highlights

Parameter	Min	Typ	Max	Unit
Cut-off frequencies	50 k	-	15 G	Hz
Output voltage	2	-	8	V _{pp}
Gain	-	28	-	dB
Saturated output power	-	-	23	dBm
Added jitter	-	850	-	fs
Rise / Fall times	-	14	-	ps

Measurements for V_{bias} = 12 V, V_{amp} = 0.5 V, V_{xp} = 0.9 V, I_{bias} = 260 mA

12.5 Gbps Output Response

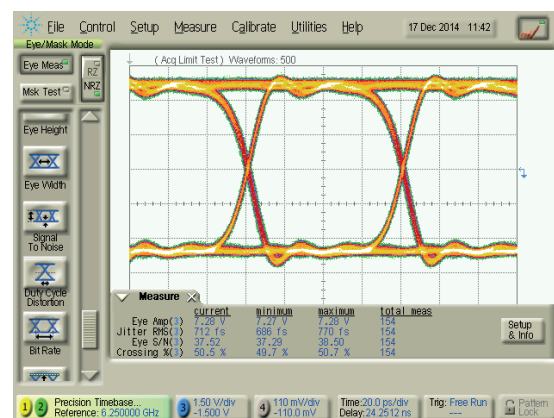

DC Electrical Characteristics

Parameter	Symbol	Min	Typ	Max	Unit
Supply voltage (fixed)	V_{bias}	-	12	-	V
Current consumption	I_{bias}	-	260	-	A
Gain control voltage	V_{amp}	-	0.5	-	V
Cross Point control voltage	V_{xp}	-	0.9	-	V

Electrical Characteristics

Parameter	Symbol	Condition	Min	Typ	Max	Unit
Lower frequency	f_{3dB} lower	-3 dB point	-	-	50	kHz
Upper frequency	f_{3dB} upper	-3 dB point	-	15	-	GHz
Gain	S_{21}	Small signal	-	28	-	dB
Gain ripple	-	$f < 15$ GHz	-	± 1.5	-	dB
Input return loss	S_{11}	$10 \text{ MHz} < f < 12 \text{ GHz}$	-	-10	-	dB
Output return loss	S_{22}	$10 \text{ MHz} < f < 15 \text{ GHz}$	-	-10	-	dB
Saturated output power	P_{sat}	$V_{in} = 0.5 V_{pp}$	22	23	-	dBm
Output voltage	V_{out}	$V_{in} = 0.5 V_{pp}$	2	-	8	V_{pp}
Rise / Fall time	t_r / t_f	20 % - 80 %	-	12 / 16	-	ps
Added jitter	J_{RMS}	$J_{RMS} = \sqrt{J_{RMS-total}^2 - J_{RMS-source}^2}$	-	850	-	fs
Noise Figure	NF	$1 \text{ GHz} < f < 20 \text{ GHz}$	3.5	-	6	dB
Power dissipation	P	$V_{out} = 8 V_{pp}$	-	3.2	-	W

Conditions: $V_{in} = 0.5 V_{pp}$, $T_{amb} = 25^\circ\text{C}$, 50 Ω system

Absolute Maximum Ratings

Stresses in excess of the absolute maximum ratings can cause permanent damage to the device. These are absolute stress ratings only. Functional operation of the device is not implied at these or any other conditions in excess of those given in the operational sections of the data sheet. Exposure to absolute maximum ratings for extended periods can adversely affect device reliability.

Parameter	Symbol	Min	Max	Unit
RF input voltage	V_{in}	-	1	V_{pp}
Supply voltage	V_{bias}	11	13	V
DC current	I_{bias}	0	0.4	A
Gain control voltage	V_{amp}	0	1.2	V
Cross Point control voltage	V_{xp}	0	1.1	V_{pp}
Power dissipation	P_{diss}	-	5.2	W
Temperature of operation	T_{op}	0	+40	$^\circ\text{C}$
Storage temperature	T_{st}	-10	+70	$^\circ\text{C}$

S_{21} and Group Delay Parameter Curves

Conditions: $V_{bias} = 12\text{ V}$, $V_{amp} = 0.5\text{ V}$, $V_{xp} = 0.9\text{ V}$, $I_{bias} = 260\text{ mA}$

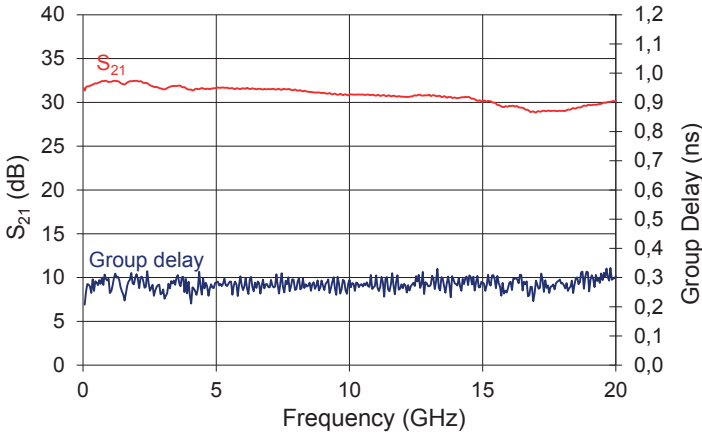

S_{12} Parameter Curve

Conditions: $V_{bias} = 12\text{ V}$, $V_{amp} = 0.5\text{ V}$, $V_{xp} = 0.9\text{ V}$, $I_{bias} = 260\text{ mA}$

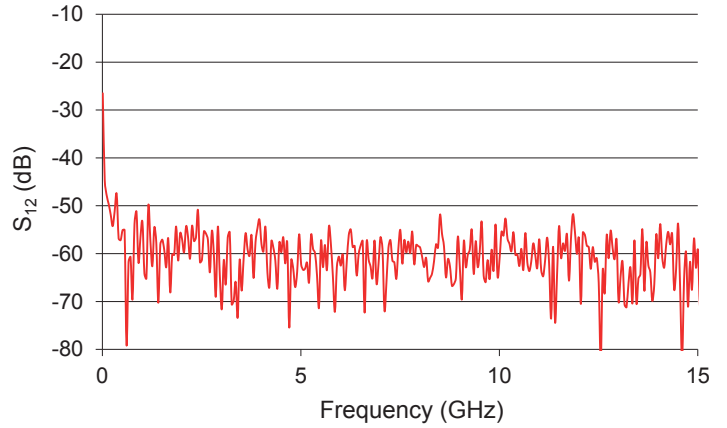

S_{22} Parameter Curve

Conditions: $V_{bias} = 12\text{ V}$, $V_{amp} = 0.5\text{ V}$, $V_{xp} = 0.9\text{ V}$, $I_{bias} = 260\text{ mA}$

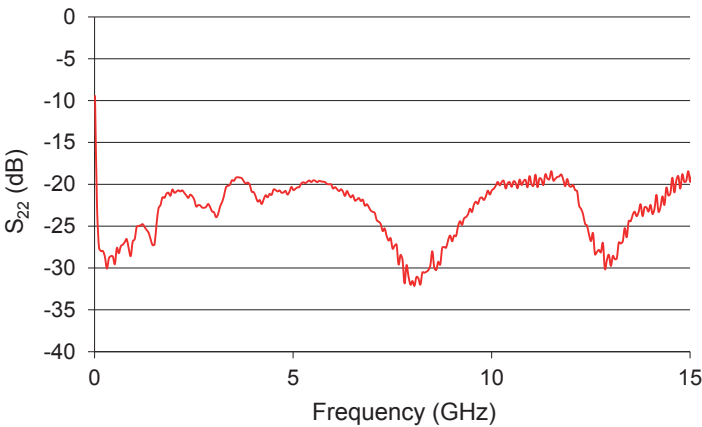

S_{11} Parameter Curve

Conditions: $V_{bias} = 12\text{ V}$, $V_{amp} = 0.5\text{ V}$, $V_{xp} = 0.9\text{ V}$, $I_{bias} = 260\text{ mA}$

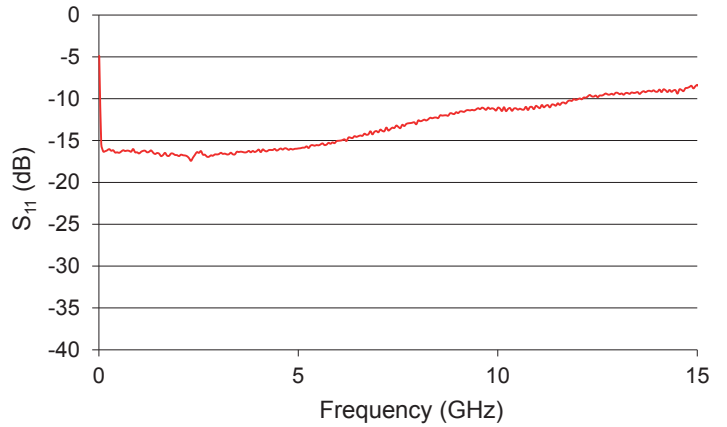

Typical Output Voltage Amplitude vs V_{amp}

Conditions: $V_{bias} = 12\text{ V}$, $V_{in} = 0.5\text{ V}$

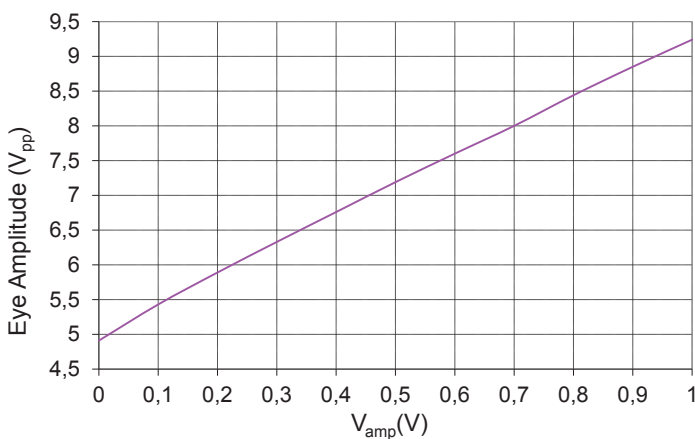

Typical Cross point vs V_{xp}

Conditions: $V_{bias} = 12\text{ V}$, $V_{in} = 0.5\text{ V}$

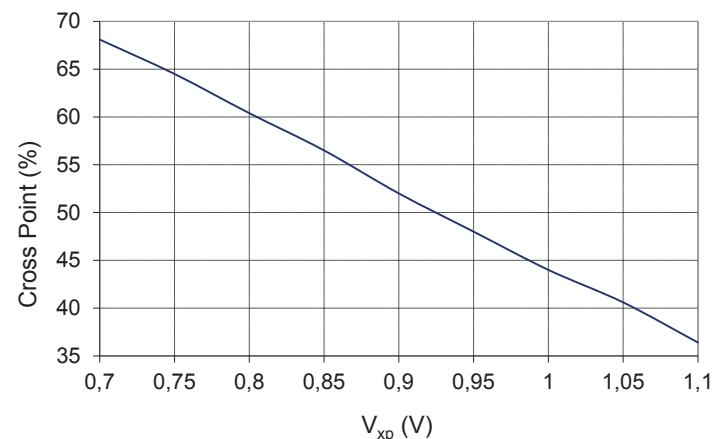

Eye Diagrams

10 Gbps data rate

Conditions: Ratio y, Pattern 2³¹-1

$$V_{\text{bias}} = 12 \text{ V}, V_{\text{amp}} = 0.8 \text{ V}, V_{\text{xp}} = 0.82 \text{ V}, I_{\text{bias}} = 279 \text{ mA}$$

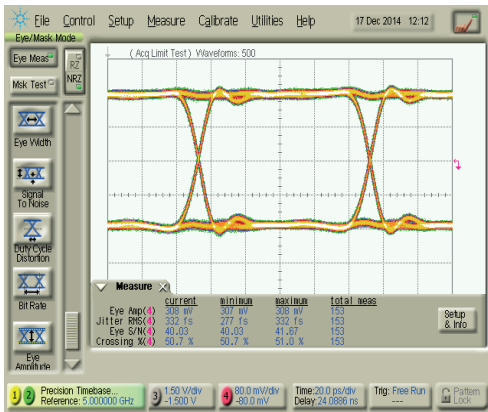

Input signal

Eye amplitude = 0.308 V_{pp}, Rise time = 9.3 ps
Jitter RMS = 332 fs, SNR = 40

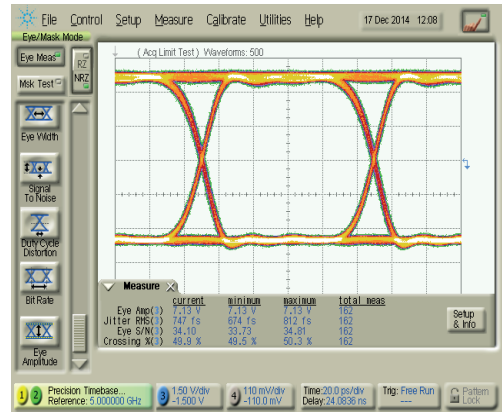

Output response

Eye amplitude = 7.13 V_{pp}, Rise time = 14.67 ps
Jitter RMS = 747 fs, SNR = 34

12.5 Gbps data rate

Conditions: Ratio y, Pattern 2³¹-1

$$V_{\text{bias}} = 12 \text{ V}, V_{\text{amp}} = 0.75 \text{ V}, V_{\text{xp}} = 0.88 \text{ V}, I_{\text{bias}} = 277 \text{ mA}$$

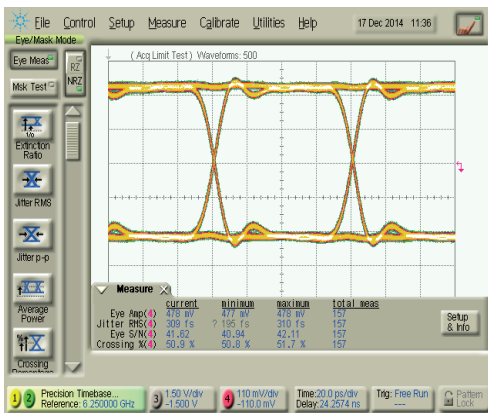

Input signal

Eye amplitude = 0.478 V_{pp}, Rise time = 9.33 ps
Jitter RMS = 309 fs, SNR = 41.6

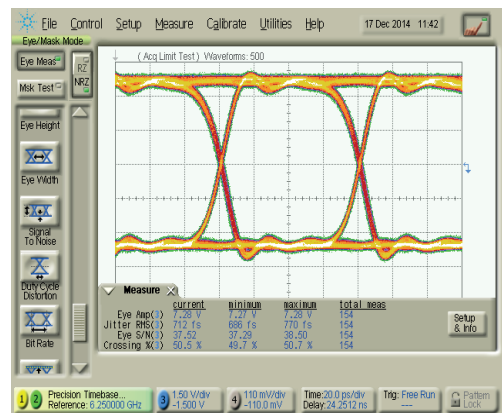

Output response

Eye amplitude = 7.28 V_{pp}, Rise time = 12.4 ps
Jitter RMS = 712 fs, SNR = 37.5

Electrical Schematic Diagram

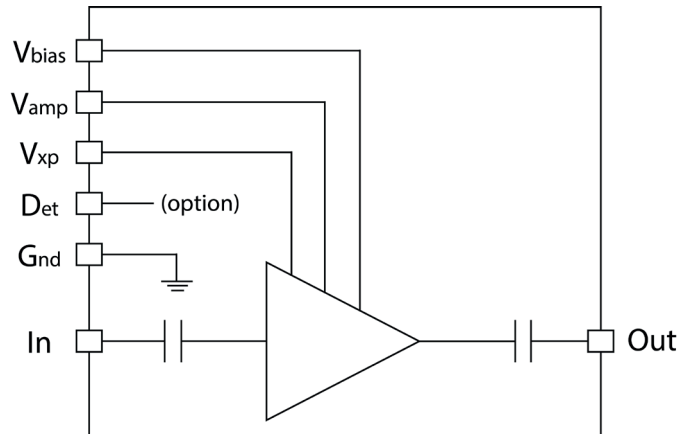

Mechanical Diagram and Pinout

All measurements in mm

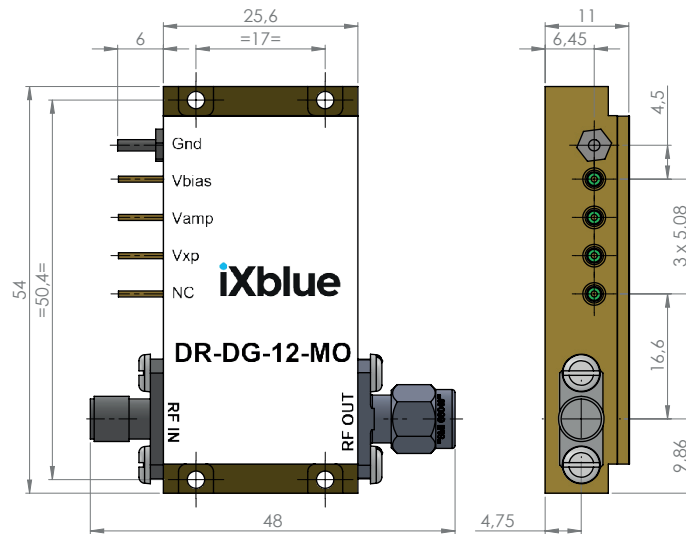

The heatsinking of the module is necessary. It's user responsibility to use an adequate heatsink. Refer to page 6 for ixBlue recommended heatsink.

PIN	Function	Operational Notes
IN	RF In	K-connector female
OUT	RF Out	K-connector male
V_{bias}	Power supply voltage	Set at typical operating specification
V_{amp}	Output voltage amplitude adjustment	Adjust for gain control tuning
V_{xp}	Output voltage cross point adjustment	Adjust for cross point control tuning

Mechanical Diagram And Pinout With HS-M02 Heatsink

All measurements in mm

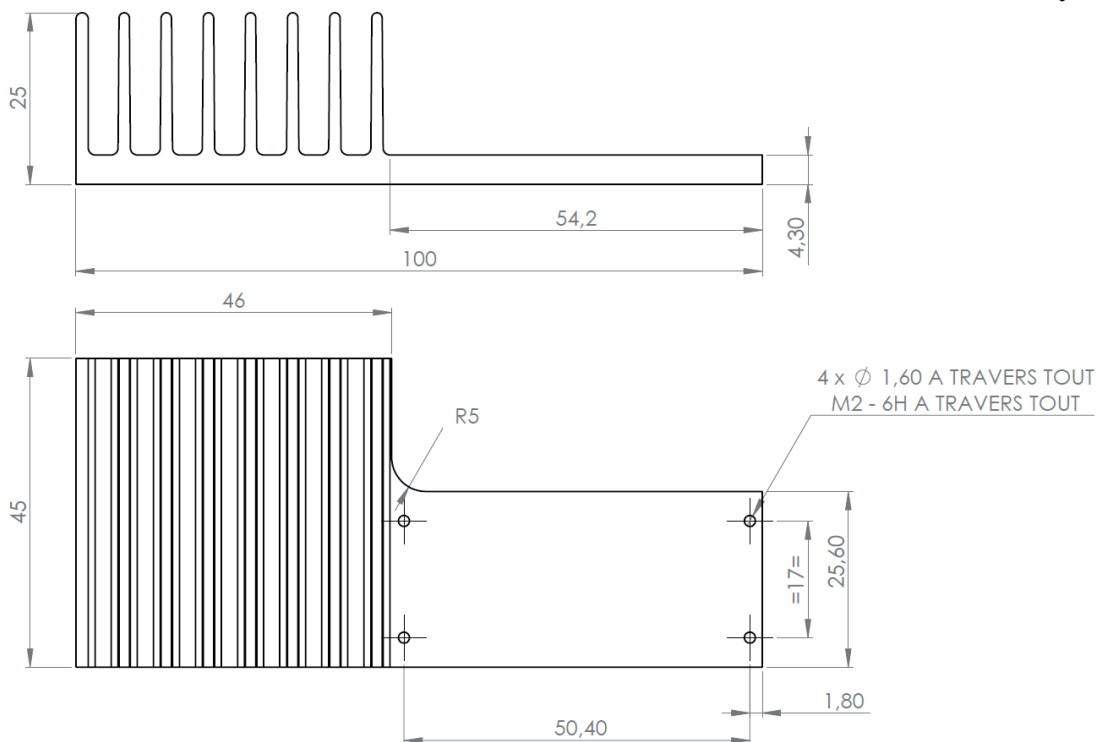
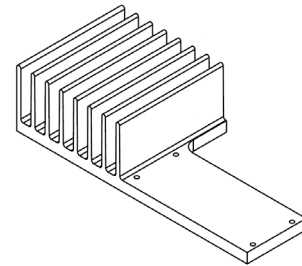

About us

ixBlue Photonics produces specialty optical fibers and Bragg gratings based fiber optics components and provides optical modulation solutions based on the company lithium niobate (LiNbO₃) modulators and RF electronic modules.

ixBlue Photonics serves a wide range of industries: sensing and instruments, defense, telecommunications, space and fiber lasers as well as research laboratories all over the world.

3, rue Sophie Germain
25 000 Besançon - FRANCE
Tel. : +33 (0) 381 853 180 - Fax : + 33 (0) 381 811 557

ixblue reserves the right to change, at any time and without notice, the specifications, design, function or form of its products described herein. All statements, specification, technical information related to the products herein are given in good faith and based upon information believed to be reliable and accurate at the moment of printing. However the accuracy and completeness thereof is not guaranteed. No liability is assumed for any inaccuracies and as a result of use of the products. The user must validate all parameters for each application before use and he assumes all risks in connection with the use of the products